

Transmission of light by fibers for optical communication. On the Nobel Prize in Physics awarded to Charles Kuen Kao, Willard S. Boyle, and George E. Smith (I)*

Santiago Vallmitjana

Department of Applied Physics and Optics, Faculty of Physics, University of Barcelona, Barcelona

Resum. El Premi Nobel de Física 2009 va atorgar el guardó compartit a Charles Kuen Kao (a més de Willard S. Boyle i George E. Smith) pels assoliments innovadors relatius a la transmissió de llum en fibres per a les comunicacions òptiques. En aquest article es descriu el rerefons científic dels anys seixanta, els antecedents tecnològics i la manera com, l'any 1966, a partir d'una publicació de Kuen Kao, es formulen unes grans expectatives relatives a la possibilitat d'enviar informació, mitjançant la llum d'un làser, a través de les fibres òptiques. Es tracten, des d'un punt de vista bàsic, el funcionament de les fibres òptiques i la tecnologia associada, així com l'estudi de les diferents dificultats, que es van superar al llarg dels anys següents fins a arribar a sistemes de comunicació fiables i a ser com són actualment.

Paraules clau: fibra òptica · telecomunicació · reflexió · dispersió · atenuació

Abstract. The Nobel Prize in Physics 2009 was divided, one half awarded to Charles Kuen Kao for innovative achievements concerning the transmission of light in fibers for optical communications (the other half was jointly awarded to Willard S. Boyle and George E. Smith). This article describes the scientific and technological background of the 1960s, and how, in 1966, from a publication from Kuen Kao, great expectations were made regarding the possibility of sending information with a laser through optical fibers. The basic functioning of optical fibers and their related technology is described, as well as the various difficulties that were overcome during the following years in order to attain reliable communication systems, such as the ones today.

Keywords: optical fibers · telecommunications · reflection · dispersion · attenuation

Throughout history, attempts have been made to use light as a means of communication; however, atmospheric absorption had always made this feat untenable. The idea was revived with the discovery of the laser in 1960; while this led to further progress, light as a means of communication was still not practically applicable because of the continued limitations posed by absorption and the difficulties in sending light directly. The idea was yet again revived with the development of fiberglass, but the problem of absorption, this time by the fibers, remained. In 1966, the work of Charles Kuen Kao renewed interest in the possibility of communication. Kao showed that the fiber-manufacturing process was the cause of the absorption problem and that under better technical conditions light could travel vast distances before being weakened by absorption. These findings unleashed an irrepressible series of technological improvements and advancements, launching the advent of a new



Fig. 1. Charles K. Kao. © The Nobel Foundation. Photo: Ulla Montan.

age in the history of telecommunications. For this reason, Charles Kao is regarded as the 'father of fiber optic communication.' (Fig. 1)

The physics of fiber optics

An optical fiber acts like a tube that conducts light. To understand how it works, we must first explore the phenomenon of total reflection.

Total reflection. In a homogeneous and uniform medium, light is transmitted in a straight line at a speed of v . The refrac-

* Based on the lecture given by the author at the Institute for Catalan Studies, Barcelona, on 15 December 2009, and at the Octubre Centre of Contemporary Culture, Valencia, on 27 January 2010 for the Nobel Prize Cycle.

Correspondence: S. Vallmitjana, Department of Applied Physics and Optics, Faculty of Physics, University of Barcelona, Martí i Franquès 1, 5th floor, E-08028 Barcelona, Catalonia, EU. Tel. +34-934021202. Fax +34-934021142. E-mail: santi.vallmitjana@ub.edu

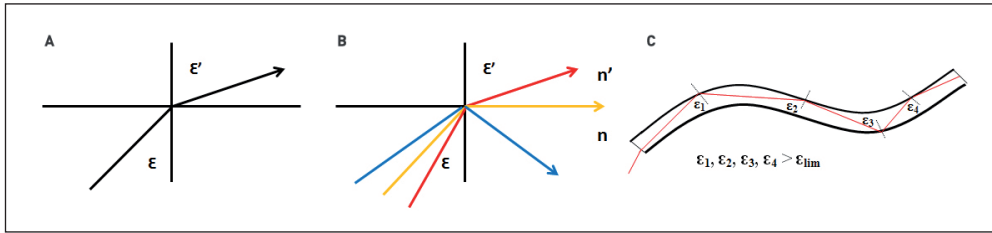

Fig. 2(A). Snell's Law of Refraction. **(B)** Refractions until they surpass the critical angle. **(C)** Successive total reflections inside an optical fiber

tive index of the medium is defined as $n = c/v$, in which c is the speed of light in a vacuum. When the light passes from a medium with a refractive index of n to another with an index of n' , entering at an angle of ϵ (measured in relation to the direction perpendicular to the surface separating the media), it changes direction by forming an angle ϵ' , such that there is a relationship between the indexes and the angles (Fig. 2A) that obeys Snell's Law of Refraction:

$$\text{Snell's Law: } n \sin \epsilon = n' \sin \epsilon'; \text{ per } n > n' \rightarrow \epsilon < \epsilon'$$

In the event that the new medium has a lower refractive index, the exit angle will increase, yielding an angle of incidence in which the exit angle is 90° . This is an interesting feature of fiber, since when light travels at this so-called critical angle it is reflected back to the same medium at the same angle. This is known as total internal reflection.

$$\epsilon_{lim}: \text{ value in which } \epsilon' = 90^\circ; \text{ total reflection: if } \epsilon > \epsilon_{lim}$$

Accordingly, light can give rise to total reflections without ever leaving the fiber (Fig. 2B,C).

Basic components and parameters. Optical fibers basically consist of two parts: the core (index n_c) and the cladding (index n_0), or external covering. There are also other, protective layers. Let us assume that light enters the fiber at an angle of θ and is refracted at an angle of α . If the angle in the second refraction (Fig. 3) is the critical angle, then:

$$n_0 \sin (90 - r) = n_c \sin 90$$

$$n_c = n_0 \cos r$$

Likewise, if we consider the input refraction, then:

$$1 \sin \theta_M = n_0 \sin r$$

Accordingly, we define the acceptance angle as the maximum angle at which the following refraction hits the critical angle $r = \epsilon_{lim}$. The sine of this angle is known as the numerical aperture (NA) of the fiber:

$$N.A. = \sin \theta_M = n_0 \sqrt{1 - \cos^2 r} = n_0 \sqrt{1 - \frac{n_c^2}{n_0^2}} = \sqrt{n_0^2 - n_c^2}$$

A large NA is not desirable because part of the light can travel to the center while the rest may give rise to numerous reflections, which would lead to dispersion of the signal. As men-

tioned above, in addition to the two fiber layers that reflect (core and cladding), there are also protective layers. A submarine cable has seven such layers (plastic, aluminum, and metal), and only the center (layer eight) comprises the fiber bundle (Fig. 4).

Dispersion and solutions. Now we must briefly discuss modal dispersion and extra-modal or chromatic dispersion.

- a) Modal dispersion. Between the best and worst cases, the light that travels through the core and edges from the same light pulse expands over time, a phenomenon known as modal dispersion. Depending on the amount of modal dispersion, there are three kinds of fibers:

1. Multimode fibers (Step index), which a higher capacity but permit greater dispersion. Their core measures several dozens or hundreds of micrometers in diameter.

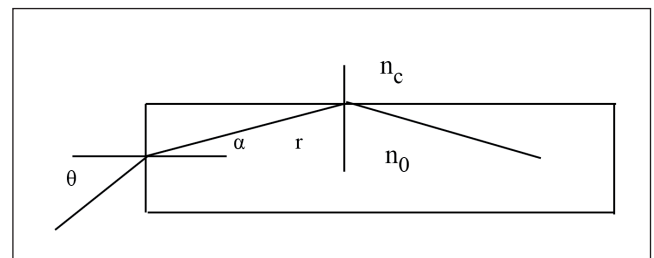

Fig. 3. Conditions for the first total reflection.

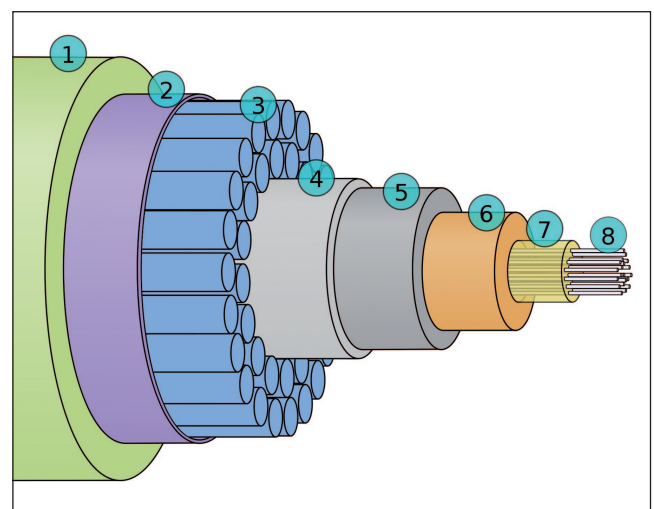

Fig. 4. Different layers of optical fiber and a submarine cable for optical communication. (1) Polyethylene; (2) mylar tape; (3) stranded steel wires; (4) aluminum water barrier; (5) polycarbonate; (6) copper or aluminum tube; (7) petroleum jelly; (8) optical fibers.

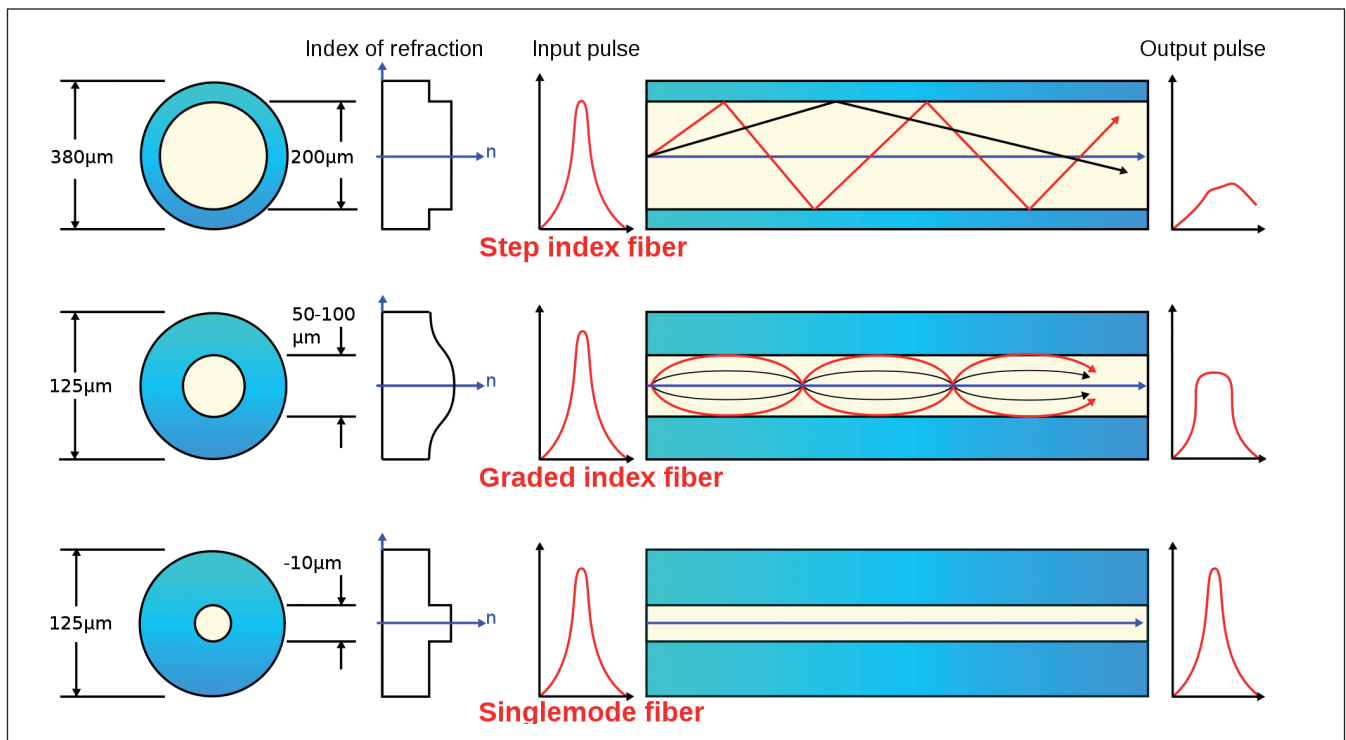

Fig. 5. Three types of fiber according to their geometry and refractive index.

2. GRIN (GRaded INdex) fibers, which are characterized by a gradual variation between the core and the cladding, leading to compensation in the optical pathways (the product of the pathway times the index) and lower dispersion.
3. Singlemode fibers. They show lower modal dispersion because of their small diameter ($< 10 \mu\text{m}$) (Fig. 5).

b) Extra-modal or chromatic dispersion. Even though modal dispersion may be controlled, if signals of different wavelengths are sent, the signals can be separated or dispersed since the refractive index depends on the wavelength. This is called extra-modal or chromatic dispersion. The index usually decreases with increasing wavelengths; therefore, the signal is quicker at longer wavelengths.

Numerous solutions have been devised to resolve this problem:

1. Interspersing components with anomalous dispersion: These fibers consist of a material that has a refractive index that increases with increasing wavelength, thus counterbalancing dispersion.
2. Interspersing Bragg fibers: These are fibers with a core refractive index that shows periodic variation and a dielectric mirror on one end, so they act via reflection; with the proper interferences they counterbalance dispersion.
3. Interspersing systems with diffraction networks: Since the longer the wavelength the greater the angle of diffraction, they can travel further, thus counterbalancing their advance.

The problem of attenuation. As light is propagated through a fiber, it gradually loses intensity, leading to attenuation of the signals transmitted. That is due to two reasons. The first involves intrinsic physical causes that can be attributed to the interaction between electromagnetic waves and matter, which leads to absorption and dispersion, or scattering, depending on the material and the wavelength. The second is that attenuation also derives from the manufacturing process, which can leave impurities or micro-flaws or even mechanical defects such as flexions and compressions, or from the technology underlying the connections.

Figure 6 shows the dependence of absorption on wavelength. There are three zones in which the absorption is lower. These define the 'three windows of communication via optical fiber,' namely bands centered at $0.8 \mu\text{m}$, $1.3 \mu\text{m}$, and $1.5 \mu\text{m}$ (the third is subdivided into 1.55 and 1.65). The improvements made over the years are apparent, since the upper and middle zones correspond to the start and end of the 1980s, while the lower zone corresponds to more recent years.

Attenuation is measured using a logarithmic scale. If a photometric value of I is introduced at the input and a value of I' at the output, attenuation can be defined as the logarithm of the quotient of I/I' . Note that if output and input are inverted, the sign changes but the value does not. It is also interesting to note that attenuation is additive: by adding fibers, the number of decibels (dB), explained below, also rises. Attenuation is measured in units of decibels (dB), named in honor of Alexander Graham Bell, and is usually expressed as decibels per kilometer (dB/km). Table 1 shows the relationship between the quotient and the value as expressed in dB. For every three dB, transmission is halved. In fibers from 1966, the attenuation was 1 dB/m or 1000 dB/km, which translated into a reduction of

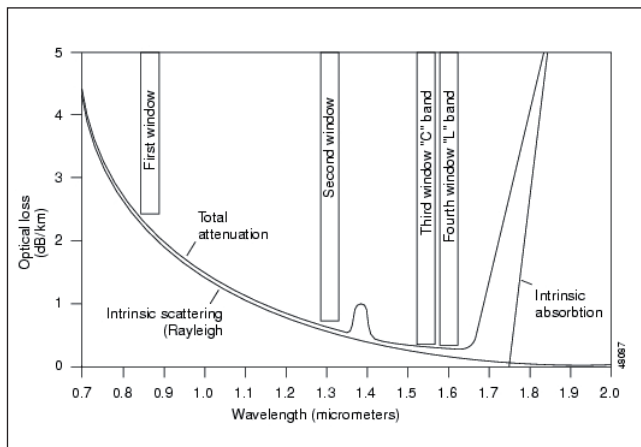

Fig. 6. Attenuation curves according to wavelength in the early 1980s, in the late 1980s, and today.

1/10,000,000,000 after 100 m; this explains why, before Kao's study, communication via fiber was regarded as unfeasible. Today, it is around 0.1 dB/km (Table 1).

Despite improvements in fiber quality, over long distances the problem of a noticeable drop in the signal coupled with an increase in the noise remained. This problem was addressed by placing regeneration stations along the way in order to amplify the incoming signals, filter out the noise, and then forward the signals. In the early days, these devices were hybrid and had to convert the optical signals into electrical ones (with photodiodes), then filter and amplify them, convert them back into optical signals using a laser, and, finally, forward them to the outgoing fiber. However, since the late 1980s optical regenerators have been used, interspersing erbium-doped fiber amplifiers (EDFAs), which use nonlinear optical effects and mixes of wavelengths to allow the incoming signals to be coupled with a laser, which amplifies them. Obviously, with improvements in attenuation, the distances between the regenerating stations have increased from dozens to hundreds of kilometers, which has fostered installations of optic communications via submarine cabling (Fig. 7).

The history of optical fiber

The earliest forerunner of optical communication dates back to the late 1790s, when the Chappe brothers, Claude (1763–1805) and Ignace (1760–1829), invented the first optical telegraph in France. The device was based on the positioning of wooden arms according to an alphabetic code. In 1842, the Swiss physicist Daniel Colladon (1802–1893) published an article in which he claimed that light could be conducted along water jets; years later, he suggested several applications of this discovery for ornamental fountains. In 1854, the Irish

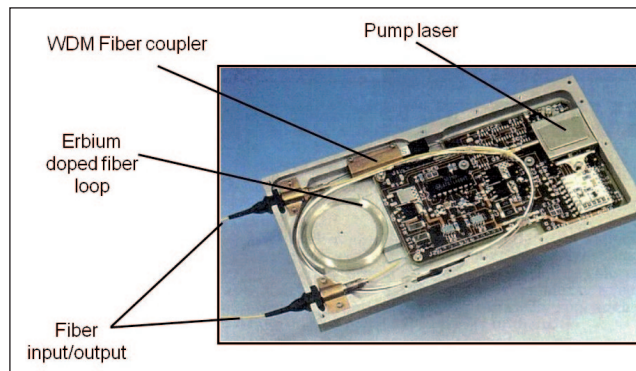

Fig. 7. Erbium-doped fiber amplifier (EDFA).

physicist John Tyndall (1820–1893), who later became famous for his studies on colloidal solutions and light dispersion (known as the Tyndall effect), carried out a series of experiments in which light was conducted through a jet of water that flowed from a container. There is also a patent dating from 1881, filed by the American scientist William Wheeler, who invented a system of water pipes able to conduct light to the rooms of a house from an electrical arc located in the basement (Fig. 8).

The first glass fibers were manufactured by the Owens Corning company in 1938, initially for thermal insulation applications. The medical fiberscope was invented in the 1950s by researchers Brian O'Brien, from the American Optical Company, and Narinder Kapany, from the Imperial College of Science and Technology of London. Kapany was the first to coin the term 'fiber optics,' in 1956. In 1954, Abraham van Heel, from the Technical University in Delft, the Netherlands, independently announced that orderly bundles of optical fibers could be used to form images. The first laser appeared in 1960 and despite its considerable power the loss rates of the fibers were of the order of 100 dB/km (1/10,000,000,000, the attenuation of the signal from entry over the length of a kilometer), which essentially ruled out its use for transmitting light at any distance.

In 1964, Charles K. Kao arrived at the conclusion that the high losses in the earlier fibers were due to impurities, not to the structure of glass itself. In their detailed analysis published in July 1966, Kao and his co-author George Hockham postulated that the fibers' loss could be reduced to < 20 dB/km (1/100 attenuation over the length of a kilometer). This claim attracted the interest of the public at large, initially in Britain and later all over the world.

Charles Kao's work

Charles Kao and George Hockham, working at the Standard Telecom Laboratory in London, published the study they entitled

Table 1. Equivalence between attenuation expressed as a quotient and in dB

I'/I	1	0.95	0.91	0.79	1/2	1/5	1/10	1/20	1/50	1/100	1/200	1/500	10-3
dB	0	0.2	0.4	1	3	6.9	10	13	16.9	20	23	26.9	30

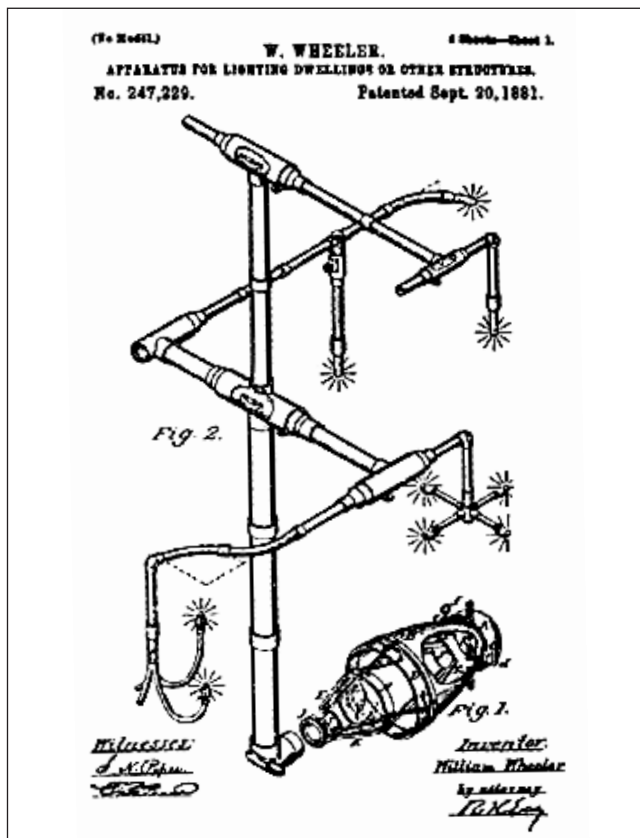

Fig. 8. William Wheeler's patent (1881).

'Dielectric-fibre surface waveguides for optical frequencies' in *Proceedings of the IEE* (issue 113, pp. 1151-1158) in 1966. The article was reissued by the same publication exactly 20 years later. George Hockham, who was the more theoretically inclined of the two, calculated the characteristics of radiation propagation through fibers, especially on curves. The study, which also included experimental tests, demonstrated that most of the losses occurring in optical fibers were the result of impurities in the glass rather than an intrinsic property of the material.

In short, these two scientists demonstrated that an optical fiber can transmit information equivalent to 200 television channels or more than 200,000 telephone channels, and they predicted that optical fibers would become capable of transmitting this information with losses of only 20 dB per kilometer. The specific claim they published was: "Conclusions are drawn as to the feasibility and the expected performance of such a waveguide for long-distance communication application," proof of their vision of the potential of optical fibers.

Constant improvements in the ability to transmit information

The claim can be made that Kao's work marked the start of a race for better fiber optic techniques, which quickly succeeded each other. Just four years later, Kao's predictions were surpassed. In the summer of 1970, Robert Maurer, Donald Keck, and Peter Schultz, all from Corning Glass, developed a glass fiber with an attenuation of 17 dB/km at 633 nm (it conveyed

65,000 times more information than achieved with copper wire). During the early 1970s, the United States Army installed a fiber optic telephone cable as part of a military program to develop communications via fiber optics. In June 1972, Maurer, Keck, and Schultz invented a multi-mode fiber doped with germanium, with a loss of 4 dB per kilometer.

In parallel with the advances in propagation, transmission speed was also improved, and in April 1977 General Telephone and Electronics installed a telephone line in Long Beach, California that used a fiber optic system operating at 6 Mbps. In May of the same year, Bell Laboratories unveiled a fiber optics telephone communication system; it was installed in Chicago and covered a distance of 1.5 miles (2.4 km). Today, more than 80% of long-distance voice and data traffic in the world is transmitted via fiber optic cables. And in late 1977, Nippon Telegraph and Telephone improved the third window to 1,550 nm, with a theoretical minimum optical loss of around 0.2 dB/km.

The first-generation systems were able to transmit light over a few kilometers without the need for repeating stations, with a loss of approximately 2 dB/km. These were quickly followed by second-generation systems, which used new InGaAsP lasers emitting at 1.3 μm and with a fiber attenuation as low as 0.5 dB/km and a dispersion under 850 nm. Optical images were first transmitted via fiber in 1980, at the Winter Olympics in Lake Placid, New York. Later, at the 1994 Winter Olympics, in Lillehammer, Norway, optical fibers transmitted digital video signals for the first time, an application that continues to evolve.

Regarding the capacity to transmit many signals along the same fiber (multiplexing), this was initially done using the TDM (time division multiplexing) method, in which each set of bits from each signal is interspersed at shorter digitalization intervals. Later, the WDM (wavelength division multiplexing) technique was developed, in which each set of bits is sent at a slightly different wavelength, thus significantly boosting transmission capacity. David Payne, from Southampton University, and Emmanuel Desurvire, from Bell Laboratories, developed the first erbium doped fiber amplifiers (EDFAs); these were introduced in 1986. EDFAs reduced the cost of long-distance fiber systems by eliminating the repeating mechanisms that converted optical signals to electronic ones, electronically amplified them, and then converted the amplified signals back to optical signals. EDFAs made it possible to transmit signals over a longer distance, enabling the launch of the first transatlantic telephone cable, in 1988. They also provided the groundwork for the DWDM (dense wavelength-division multiplexing) technique.

In 1990, at Bell Laboratories, a 2.5 Gb/s signal was transmitted 7,500 km without regeneration. In 1996, the first totally fiber optic cable, the TPC-5, which uses optical amplifiers, was laid across the Pacific Ocean. In 1998, using DWDM technology a fiber could transmit 100 optical signals simultaneously, each at 10 Gbits/s at distances of 250 miles (400 km) for a total speed of 1 Tbit/s (one trillion bits per second). Around 1994, submarine cables were operating at 1.55 μm , with losses of 0.2-0.3 dB/km at speeds of 5 GBit/s. The distance between amplifiers was 50-80 km.

Telecommunications companies laid down approximately 523,000 km of submarine cabling between 1998 and 2002,

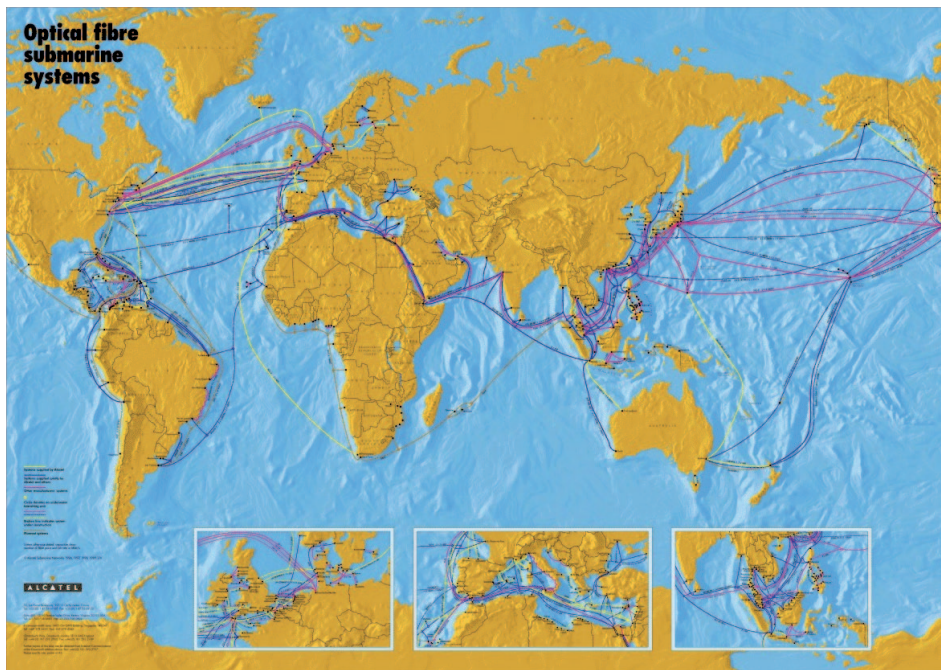

Fig. 9. Map showing submarine cable lines laid down by Alcatel.

which made even higher volumes of simultaneous voice calls and data transfer possible via the Internet. In the UK, 3 million kilometers of fiber optic cabling have been laid since Kao's original prediction. By 2005, half a billion (500 million) people regularly used the Internet and 40 million private homes were wired. By 2009, there were 1.734 billion Internet users (the one billion mark had been passed in 2008). Today, optical fibers transmit surprising volumes of data. After the summer of 2009, Bell Laboratories beat the optical transmission record by sending the equivalent of 400 DVDs more than 7000 km/s, thus outstripping submarine cables by a factor of ten. Fiber optic cables are constantly connecting the world even further; a 17,000-km cable installed this past July links east Africa with Europe and India at speeds fast enough to transmit high-definition video (Fig. 9).

Over the past 40 years, technological developments associated with IT have also achieved major strides. While Moore's Law posits that computers duplicate their power every 18 months, according to an interesting version of this law in the world of telecommunications known as 'Moore's law of optics' the transmission capacity via fiber optics doubles in intervals of 4–12 months depending on the country's infrastructure and the quality of the installations. To conclude this technical survey, let us compare telecommunications sent via copper wire with those sent via fiber optics. The advantages of optical communication can be summarized as follows: as we have seen based on the figures above, multichannel capacity and bandwidth have risen considerably at a lighter weight; furthermore, optical fibers are impervious to moisture and more resistant to certain gases and liquids. They are immune to electromagnetic fields and interferences, and they exhibit a high level of safety in terms of privacy (they cannot be breached through induction, and any deviation is detected). The disadvantages include attenuation and the consequent need for regenerators-repeaters, as well as fragility (protective plastic layers are always re-

quired) and the technical complexity of the connections. Finally, in addition to their aforementioned applications in telecommunications, fiber optics are very important in medicine (in diagnostics and surgery, which rely on endoscopes to illuminate anatomic/surgical regions and to produce images from blood vessels or other anatomic structures), in the automotive industry (to transmit signals inside automobiles), in architecture, and increasingly in many other technologies.

Brief biography of the Nobel Prize winner

Charles Kuen Kao was born in Jiangsu, a district of Shanghai, on 4 November 1933. In 1948, his family moved to Hong Kong, and in 1952 he graduated from secondary school at St. Joseph's College in Hong Kong. After studying electrical engineering at Woolwich Polytechnic (now the University of Greenwich), where he earned a Bachelor's of Science, he undertook graduate studies at University College London, receiving his Doctorate in Electrical Engineering in 1965. While pursuing his doctorate, he worked as an engineer at Standard Telephones and Cables (STC, later Nortel Networks) and at the Standard Telecommunications Laboratories (STL) research center in Harlow, England. At STL, he conducted the research that led to the famous 1966 publication (Fig. 10), co-authored with his colleague, George Hockham. In 1970, he was hired by the Chinese University of Hong Kong (CUHK), where he founded the Department of Electronics (later renamed the Department of Electronic Engineering). In 1974, he moved to the United States to work at ITT (associated with STC). He then moved to the company's facilities in Roanoke, Virginia, where he was Chief Scientist and then Director of Engineering. In 1982, he was named ITT Executive Scientist, at the Advanced Technology Center in Connecticut. He also worked as an adjunct professor at Trumbull College, part of Yale University.



Dielectric-fibre surface waveguides for optical frequencies

K. C. Kao, B.Sc.(Eng.), Ph.D., A.M.I.E.E., and G. A. Hockham, B.Sc.(Eng.), Graduate I.E.E.

Synopsis

A dielectric fibre with a refractive index higher than its surrounding region is a form of dielectric waveguide which represents a possible medium for the guided transmission of energy at optical frequencies. The particular type of dielectric-fibre waveguide discussed is one with a circular cross-section. The choice of the mode of propagation for a fibre waveguide used for communication purposes is governed by consideration of loss characteristics and information capacity. Dielectric loss, bending loss and radiation loss are discussed, and mode stability, dispersion and power handling are examined with respect to information capacity. Physical-realisation aspects are also discussed. Experimental investigations at both optical and microwave wavelengths are included.

List of principal symbols

J_n = n th-order Bessel function of the first kind
 K_n = n th-order modified Bessel function of the second kind
 β = $2\pi/\lambda$, phase coefficient of the waveguide
 J_n' = first derivative of J_n
 K_n' = first derivative of K_n
 k_z = radial wavenumber or decay coefficient
 ϵ_0 = relative permittivity
 k_0 = free-space propagation coefficient
 a = radius of the fibre
 γ = longitudinal propagation coefficient
 k = Boltzman's constant
 T = absolute temperature, degK
 β_p = isothermal compressibility
 λ = wavelength
 n = refractive index
 $H_n^{(1)}$ = n th-order Hankel function of the 1st type
 $H_n^{(2)}$ = derivation of $H_n^{(1)}$
 ν = azimuthal propagation coefficient = $\nu_1 - \nu_2$
 τ = modulation period
 Subscript n is an integer and subscript m refers to the m th root of $J_n = 0$

boundary conditions imposed by the physical structure, the characteristic equations are as follows:

for HE_{nm} modes

$$\frac{n^2 \beta^2}{k_0^2} \left(\frac{1}{n_1^2} + \frac{1}{n_2^2} \right) = \left(\frac{\epsilon_1 J_n'(u_1)}{n_1 J_n(u_1)} - \frac{\epsilon_2 K_n'(u_2)}{n_2 K_n(u_2)} \right) \times \left(\frac{1 J_n'(u_1)}{n_1 J_n(u_1)} + \frac{1 K_n'(u_2)}{n_2 K_n(u_2)} \right) \quad (1)$$

for E_{0nm} modes

$$\frac{\epsilon_1 J_n'(u_1)}{n_1 J_n(u_1)} = - \frac{\epsilon_2 K_n'(u_2)}{n_2 K_n(u_2)} \quad (2)$$

for H_{0nm} modes

$$\frac{1 J_n'(u_1)}{n_1 J_n(u_1)} = - \frac{1 K_n'(u_2)}{n_2 K_n(u_2)} \quad (3)$$

The auxiliary equations defining the relationship between u_1 and u_2 are

$$u_2^2 + u_1^2 = (k_0 a)^2 (\epsilon_1 - \epsilon_2)$$

Fig. 10. Charles Kao in the 1960s and an excerpt from the first page of his published study.

He is the recipient of numerous academic awards and honorary doctorates, and has served in many administrative university posts. Between 1987 and 1996, he was the Vice-Chancellor of the CUHK. He was also the Chairman and CEO at Transtech (advanced materials and ceramics) in Massachusetts and Chairman and CEO of ITX Services (Information Technology Experts Inc.). He also founded the Independent School Foundation Academy (ISF) within the Cyberport complex (Hong Kong's counterpart to Silicon Valley). On 6 October 2009, he was awarded the Nobel Prize "for groundbreaking achievements concerning the transmission of light in fibers for optical communication."

He married M.Y. Huang, a Chinese British citizen, in 1959 in London. They have two children, a son and a daughter, who live and work in Silicon Valley, California. Today he resides in Hong Kong and although he is suffering from the onset of Alzheimer's disease, he was able to receive his Nobel Prize on 10 December 2009.

To learn more

Fiber optics in general

- <http://www.ciscopress.com/articles/article.asp?p=170740>
- <http://www.fiber-optics.info>
- <http://www.lanshack.com/fiber-optic-tutorial-basics.aspx>
- <http://www.networktutorials.info/tutorials.html>

Single-mode and multi-mode fibers

- <http://www.arcelect.com/fibercable.htm>

Transoceanic fibers

- <http://www.atlantic-cable.com/Cables/CableTimeLine/index1850.htm>
- http://en.wikipedia.org/wiki/List_of_international_submarine_communications_cables
- http://www.networktutorials.info/submarine_cable.html

Timeline

- <http://www.sff.net/people/jeff.hecht/chron.html>

Charles Kao

- <http://bibliotecaetsitupm.wordpress.com/2009/10/06/charles-kuen-cao-premio-nobel-de-fisica-2009-en-biblioteca-etsit>
- http://www.ieeeeghn.org/wiki/index.php/Oral-History:Charles_Kao
- http://nobelprize.org/nobel_prizes/physics/laureates/2009/kao.html

Bibliography

1. Hecht J (1999) City of Light: The Story of Fiber Optics. Oxford University Press, New York
2. Hecht J (2005) Understanding Fiber Optics, 5th ed. Prentice Hall, New Jersey
3. Hecht E (2001) Optics, 4th ed. Addison Wesley, UK
4. Sivalingam KM, Subramaniam S (eds) (2002) Optical WDM networks: Principles and practice. Kluwer Academic Publishers, Norwell, Massachusetts
5. Young M (1993) Optics and lasers: Including fibers and optical waveguides. Springer, Berlin