

Discovering new arene-catalyzed lithiations

Miguel Yus*

Institute of Organic Synthesis, University of Alacant

Resum. La litiació catalitzada per hidrocarburs aromàtics és una metodologia útil i versàtil que promou els processos de litiació en condicions de reacció molt suaus. Aquest informe presenta els resultats recents en l'aplicació d'aquesta tecnologia, principalment en els camps següents: *a*) carbolitiació intramolecular vs. obertura d'anells en litiometilcicloalcans, *b*) la generació de sintons de diliti com a precursors dels èters bicíclics i espiroèters, les principals unitats de productes naturals biològicament actius, *c*) desprotecció general dels diversos compostos protegits que contenen oxigen, sofre i nitrogen en condicions no hidrolítiques, i *d*) la preparació de nanopartícules de níquel i la seva aplicació en reaccions de formació d'enllaços carboni-carboni i carboni-nitrogen.

Paraules clau: litiació · compostos organolítics · carbociclització · èters bicíclics · desprotecció · nanopartícules de níquel.

Summary. Arene-catalyzed lithiation is a useful and versatile methodology that promotes lithiation processes under very mild reaction conditions. This report presents recent results in the application of this technology, mainly in the following fields: (a) intramolecular carbolithiation vs. ring-opening in lithiomethylcycloalkanes; (b) the generation of dilithium synthons as precursors of bicyclic and spiro ethers, major units in biological active natural products; (c) general deprotection of different oxygen-, sulfur-, and nitrogen-containing protected compounds under non-hydrolytic conditions; and (d) the preparation of nickel nanoparticles and their application in carbon-carbon and carbon-nitrogen bond formation reactions.

Keywords: lithiation · organolithium compounds · carbocyclization · bicyclic ethers · deprotection · nickel nanoparticles

Introduction

Carbon-carbon bond formation is one of the most important reactions in synthetic organic chemistry, as it is the mechanism by which the backbone of any organic molecule is formed. To that end, organolithium compounds, as a source of carbanionic components, play a pivotal role by reacting with carbon electrophiles [44,59]. Different methods are used to generate an organolithium intermediate, including: (i) deprotonation of compounds bearing activated hydrogen atoms, using a lithium base (a lithium amide or an organolithium reagent); (ii) halogen/lithium exchange, mainly starting from brominated or iodinated materials and using either lithium metal or an organolithium compound. Other procedures, such as carbon-heteroatom (heteroatom: oxygen, nitrogen, or sulfur) bond reductive cleavage, the addition of lithium or an organolithium compound to carbon-carbon multiple bonds, tin- or mercury-lithium transmetalations, or the Shapiro reaction, are far less commonly employed [44]. However, the use of chlorinated starting materials and lithium

metal may offer the best combination for preparing an organolithium, considering the stability and price of the substrates and the source of the metal. However, chlorine/lithium exchange is problematic, especially at low temperatures, due to the low reactivity of the carbon-chlorine bond; therefore, it is usually necessary to activate the metal in order to obtain the corresponding lithiation. Among the different procedures to activate lithium, arene-promoted lithiation [59] is probably the most effective from a preparative point of view, as it can be performed either stoichiometrically [45] or catalytically [61]. In the first case, an arene [naphthalene and 4,4'-di-*tert*-butylbiphenyl (DTBB) being the most commonly used] and lithium metal are dissolved in equimolecular amounts in tetrahydrofuran and used in solution [60]. In the catalytic version, a substoichiometric amount (<10%) of the arene is used in the presence of an excess of lithium in the same solvent [58,63]. The catalytic reaction has been shown to be more effective than the stoichiometric one, the probable reason being the participation in the first case of an arene dianion instead of the corresponding arene radical-anion, widely accepted as the electron-transfer agent for the stoichiometric reaction. The arene dianion is a much more potent electron-transfer agent than the corresponding radical anion, transferring electrons to the substrate in a single-electron transfer (SET) process [52,53].

* Correspondence: M. Yus, Institut de Síntesi Orgànica, Universitat d'Alacant. Apartat 99, E-03080 Alacant, EU. Tel. +34-965903548. Fax +34-96590354. E-mail: yus@ua.es

Arene-catalyzed lithiation has been successfully used in the following reactions: (i) the preparation of simple organolithium compounds starting from non-halogenated precursors (alcohols, ethers, silyl ethers, thioethers, sulfoxides and sulfones, sulfonates, sulfonamides, carbonates, carbamates, and ureas) [48]; (ii) preparation of very sensitive functionalized organolithium compounds by chlorine/lithium exchange [43,54,55], sulfur/lithium exchange [47] or reductive ring opening of heterocycles [62,65]; (iii) generation of dilithiated synthons [46]; and (iv) activation of transition metals [18,36].

In this report, achievements made during the last few years using the arene-catalyzed lithiation methodology are discussed.

Intramolecular carbolithiation vs. ring opening

The carbolithiation of a carbon-carbon double bond consists of the addition of an organolithium reagent to an olefin, yielding a new organolithium intermediate having at least two more carbon atoms [50]. A significant advantage of this process is that the new organolithium can then react with an electrophile, such that in only one synthetic operation profound changes can take place in the starting material. Carbolithiation can take place in two ways, inter- or intramolecularly, with the latter of special interest in the preparation of functionalized cyclic compounds. We explored the possibility of effecting an intramolecular carbolithiation in which the initial organolithium compound was generated by the arene-catalyzed lithiation of a chlorinated precursor. Thus, lithiation of 6-chloro-1-hexene (**1**) in the presence of DTBB (5%) led to the intermediate **2** which is stable at -78°C and which reacted with different electrophiles to yield the unsaturated products **3** (Fig. 1). However, if the reaction was allowed to warm to -30°C , a carbolithiation took place that yielded exclusively the new organolithium **4** and the final cyclic compounds **5** by treatment with an electrophile (Fig. 1) [64,67].

Although the reaction shown in Fig. 1 was successfully applied to other terminal alkenes (such as compounds **6** and **7**) to yield acyclic or cyclic compounds, for substituted substrates **8** and **9**, only the corresponding cyclic products were isolated.

However, for small rings, carbolithiation is not a favored process; instead, ring opening is preferred. This process was studied with cyclopropyl- and cyclobutylmethyl lithium (**12** and

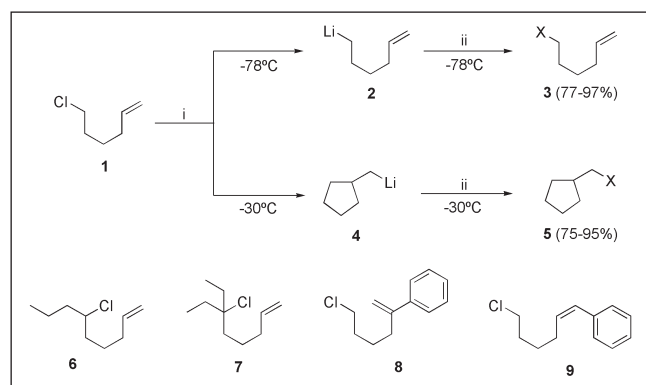

Fig. 1. Reagents: (i) Li, DTBB (5%), THF; (ii) electrophile = Bu^tCHO, PhCHO, Et₂CO, (CH₂)₅CO, PhCOMe, then HCl-H₂O.

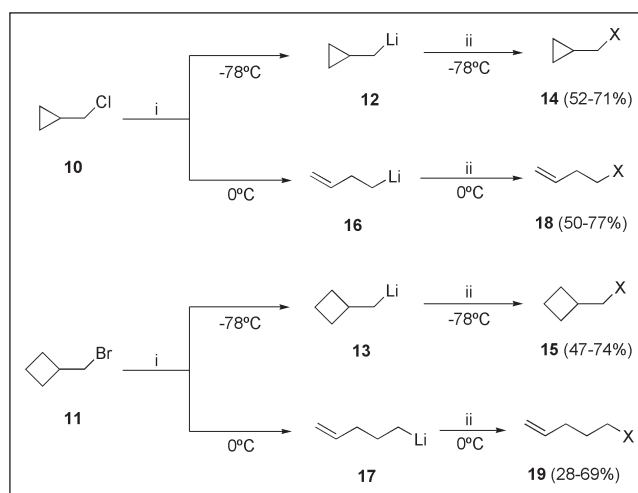

Fig. 2. Reagents: (i) Li, DTBB (for **10**) or C₁₀H₈ (for **11**) (5%), THF; (ii) electrophile = PrⁱCHO, Bu^tCHO, PhCHO, Et₂CO, Prⁿ₂CO, (*c*-C₃H₅)₂CO, (CH₂)₅CO, PhCOMe, then H₂O.

13, respectively), generated using the above-mentioned methodology by chlorine- or bromine-lithium exchange and starting from materials **10** and **11**, respectively (Fig. 2). At -78°C and with DTBB as the catalyst (5%), only cyclized products **14** and **15** were isolated, whereas when the reaction was carried out at 0°C or at ambient temperature, with naphthalene as the electron carrier catalyst (5%), the corresponding open-chain products **18** and **19** were obtained through the intermediates **16** and **17**, respectively (Fig. 2) [56]. Organolithiums **16** and **17** are formed by ring opening of the firstly generated intermediates **12** and **13**, respectively, proving that, for small rings, ring opening is preferred over the corresponding carbolithiation (transformation of **16** to **12** or **17** to **13**).

Bicyclic and spiro ethers through dilithium synthons

Many natural products with important biological activity contain a bicyclic [16] or spiro ether [28] moiety as a key structural motive. In an alternative approach, we have used dilithium synthons [46] to prepare polyfunctionalized molecules in only a single synthetic operation by reaction with electrophiles. An example is the synthesis of the spiro compounds **22** synthesized from the dichloroalkene **20** in two steps: (a) lithiation with DTBB (5%) as catalyst in the presence of a carbonyl compound (Barbier-type conditions) [4] followed by hydrolysis to yield diol **21**, and (b) successive treatment with sodium hydride and iodine, both steps at 0°C (Fig. 3) [13]. In addition, compound **22** can be easily oxidized to yield spiro lactone **23**, a structural unit frequently present in many biologically active natural products.

Spiro ethers having two five-membered cyclic ethers were also prepared using arene-catalyzed lithiation as the key step. In this case, the starting material was the chloro ether **24**, which by lithiation with naphthalene as catalyst (2.5%) in the presence of a carbonyl compound followed by treatment with an epoxide generated, after hydrolysis, the corresponding diol **25** (Fig. 4). These compounds were treated with iodine and silver oxide to afford

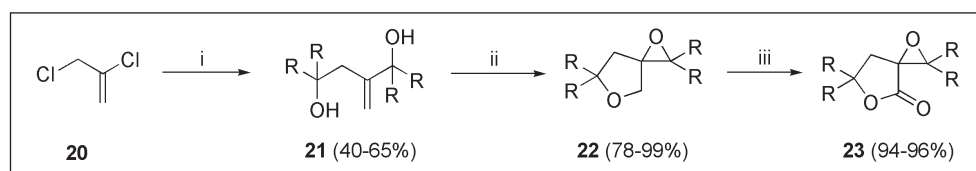
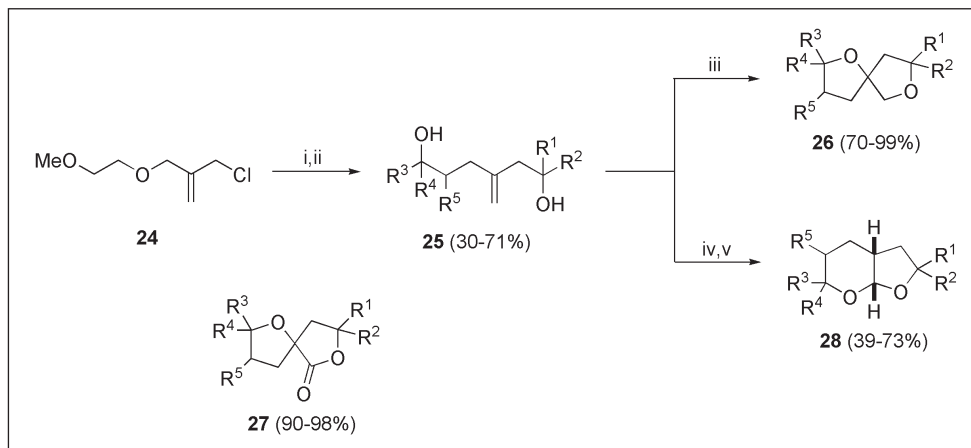

Fig. 3. Reagents: (i) Li, DTBB (5%), $R_2CO = Et_2CO, (c-C_3H_5)_2CO, (CH_2)_5CO, Y(CH_2CH_2)_2CO$ [$Y = O, S, Pr^iN$], adamantan-2-one, THF, then H_2O ; (ii) NaH, THF, then I_2 ; (iii) $NaIO_4, RuO_2$ (cat.), CCl_4 .

Fig. 4. Reagents: (i) Li, $C_{10}H_8$ (2.5%), $R^1R^2CO = Et_2CO, (CH_2)_4CO, (CH_2)_5CO, O(CH_2CH_2)_2CO$, adamantan-2-one, THF, -78 to $0^\circ C$; (ii) $R^3R^4C(O)CHP^5 = MeCH(O)CH_2, PhCH(O)CH_2, n-C_6H_{13}CH(O)CH_2, Et_2C(O)CH_2, PhMeC(O)CH_2, (n-C_5H_{11})_2C(O)CH_2$, cyclopentene oxide, cyclohexene oxide, methylenecyclohexane oxide, methyleneadamantane oxide, $0^\circ C$, then H_2O ; (iii) I_2, Ag_2O , THF; (iv) $BH_3 \cdot THF$, then $H_2O_2 \cdot NaOH$; (v) PCC or $Ru(PPh_3)_3Cl_2, CH_2Cl_2$.



1,7-dioxaspiro[4.4]nonanes (**26**), also readily oxidized to yield the new bicyclic lactone **27**, which, like the spiro compound, is a structural moiety present in many active natural products [17,20].

Another interesting class of bicyclic ethers is the family of perhydrofuro[2.3-*b*]pyrans (**28**), which are directly accessible from diols (**25**) by successive hydroboration and oxidation [15,17].

More recently [21], we applied the arene-catalyzed technology to prepare a series of bicyclic and spiro compounds, with the key step being a sulfur-lithium exchange [47] starting from dithioethers. The unsaturated material **29** was subjected to the catalytic lithiation protocol in the presence of carbonyl compounds, resulting in the isolation of unsaturated diol **30** after hydrolysis (Fig. 5). These compounds were further treated with iodine and silver triflate, yielding the corresponding 1,7-dioxaspiro[4.5]decanes (**31**), which could be oxidized to the expected bicyclic lactone **32** [24]. Unexpectedly, the treatment described above for compound **28** in this case produced the *cis*-bicycle

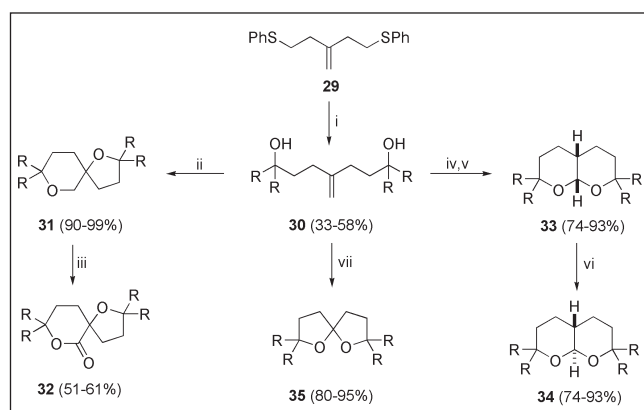

Fig. 5. Reagents: (i) Li, DTBB (2.5%), $R_2CO = Et_2CO, Pr^i_2CO, Bu^t_2CO, (n-C_5H_{11})_2CO, (c-C_3H_5)_2CO, (CH_2)_4CO, (CH_2)_5CO, Y(CH_2CH_2)_2CO$ [$Y = O, S, Pr^iN$], adamantan-2-one, THF, $0^\circ C$, then H_2O ; (ii) $I_2, AgOTf$, THF; (iii) $NaIO_4, RuO_2$ (cat.), CCl_4 ; (iv) $BH_3 \cdot THF$, then $H_2O_2 \cdot NaOH$; (v) PCC, CH_2Cl_2 ; (vi) *p*-TSA, $CHCl_3$; (vii) $O_3, CH_2Cl_2, -78^\circ C$.

33, which kinetically is the most stable of this group of compounds. In fact, its treatment with a catalytic amount of *p*-toluene sulfonic acid resulted in high yields of the corresponding thermodynamically most stable *trans*-derivative **34** [25]. Finally, direct ozonolysis of diol **30** at low temperature directly afforded the spiro ketal **35** [51].

Deprotection of oxygen-, nitrogen- and sulfur-containing compounds

One important operation in total synthesis is the protection of sensitive functionalities during a reaction, which should be deprotected at the end of the process. In this context, arene-catalyzed lithiation has proven to be an efficient methodology for protected alcohols, amines, and thiol derivatives. Thus, allylic ethers and amines **37** [5] as well as benzylic ethers and amines **38** [5] (including the corresponding tritylic derivatives [41,66]) were efficiently deprotected by an arene (naphthalene or DTBB) catalyzed (5–10%) lithiation following by simple hydrolysis,

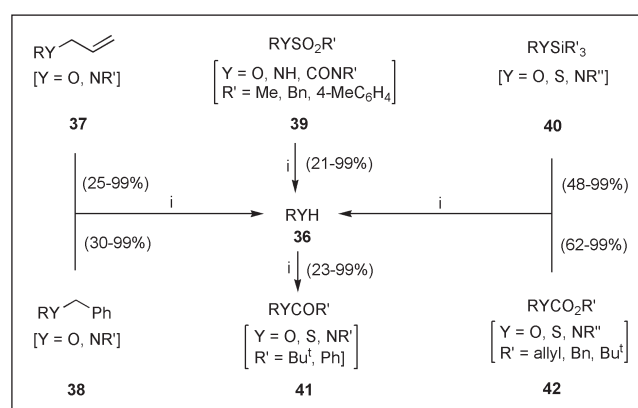

Fig. 6. Reagents: (i) Li, $C_{10}H_8$ or DTBB (5–10%), $0^\circ C$, then H_2O .

yielding the expected product **36** (Fig. 6). The same methodology was highly versatile in the desulfonylation of sulfonates and sulfonamides **39** [22], and in the desilylation of several silyl ethers, thioethers, and amines **40** [42]. The deacylation of carboxylates, thiocarboxylates, or carboxamides **41** is an important process that liberates the corresponding alcohols, thiols, or amines, respectively. While it is normally performed under acidic hydrolytic conditions, in our hands *in situ* catalytic lithiation hydrolysis represents a reasonable alternative [40]. Finally, one important family of protecting groups for carboxylic acids consists of carbonate derivatives, such as the allyloxycarbonyl-, benzyloxycarbonyl-, and *tert*-butyloxycarbonyl- (Boc) derivatives **42**. All these compounds were deprotected in a very general fashion by using the above-described protocol [1,39].

Ni-nanoparticles in carbon-carbon and carbon-nitrogen bond-forming reactions

Nickel nanoparticles [19,23], prepared by reduction of nickel(II) chloride with lithium and a catalytic amount of an arene in combination with a hydrogen source, have been widely used in a versatile and practical methodology to reduce a variety of organic functionalities [18,36]. As hydrogen source, water (or deuterium oxide) [2,3,6,7–10,12,57], molecular hydrogen [11,14], or an alcohol (ethanol [26,27,29] or isopropanol [34,35,37]) have been successfully employed, and the corresponding reduced functional groups being olefins [2,10,11,14,27,29,37], acetylenes [3,11,14,27], halogenated compounds [7,11,12,14], sulfonates [57], aromatic derivatives [11,14,57], carbonyl compounds and their imines [6,26,34,35], and nitrogen-containing compounds (hydrazines, azo and azoxy compounds, amine oxides [8,11,14], and nitrones [9]).

In the last few years, we have also used nickel nanoparticles to induce carbon-carbon or carbon-nitrogen bond formation. In this case, besides the classical homocoupling of aromatic and heteroaromatic iodides to yield diaryl or dihetaryl deriva-

tives, respectively [32], the nickel nanoparticles were used in the four processes shown in Fig. 7. The first is the reductive amination of an aldehyde **43** using a primary amine **44** in the presence of isopropanol, to yield a secondary amine **45**; this reaction involves *in situ* formation of the corresponding imine followed by its hydrogen-transfer reduction [33]. The second consists of the alkylation of a methyl ketone **46** with a primary alcohol **47** to yield ketone **48** [30,31]; this is an interesting reaction from both a mechanistic (alcohol acts here as an electrophile, its normal reactivity being as a nucleophile) and a practical (this is a good example of “green chemistry” since the only byproduct in the reaction is water) point of view. In the third, an indirect aza-Wittig reaction using a primary alcohol **49** and an iminophosphorane **50** as reagents yields a secondary amine **51**. This reaction is of preparative interest because it includes the use of readily available (inexpensive, stable) alcohols instead of aldehydes as substrates; mechanistically, it belongs to the so-called hydrogen autotransfer reactions [49]. Lastly, the indirect Wittig reaction, again starting from a primary alcohol **49**, uses a typical ylide **52** such that olefins **53** are obtained as a *Z/E* mixture, which can be easily treated with a catalytic amount of iodine under hexane reflux to comprise only the *E*-diastereomer [38]. Using this last methodology, we prepared a family of 5-substituted resorcinols (including resveratrol) of significant biological activity.

Conclusions

From the chemistry described herein, it can be concluded that arene-catalyzed lithiation is an effective methodology to carry out lithiation processes involving halogen-, oxygen-, sulfur-, and nitrogen-lithium exchange, as well as the reduction of nickel(II) salts to nickel nanoparticles. All of these reactions find a wide application in synthetic organic chemistry.

Acknowledgements

This work was supported by the Spanish Ministry of Science and Innovation (recent grants: CTQ-2004-01261, CTQ-2007-65218 and CONSOLIDER INGENIO 2010-CSD2007-0006), the Autonomous Government of Valencia (PROMETEO 2009/039), FEDER, and the University of Alacant.

References

- [1] Almansa R, Behloul C, Guijarro D, Yus M (2007) Reductive removal of the Boc protecting group via a DTBB-catalysed lithiation reaction. *Arkivoc* vii:41-50
- [2] Alonso F, Yus M (1996) Hydrogenation of olefins with hydrated nickel chloride, lithium and a catalytic amount of naphthalene. *Tetrahedron Lett* 37:6925-6928
- [3] Alonso F, Yus M (1997) Hydrogenation of alkynes with hydrated nickel chloride, lithium and a catalytic amount of naphthalene. *Tetrahedron Lett* 38:149-152

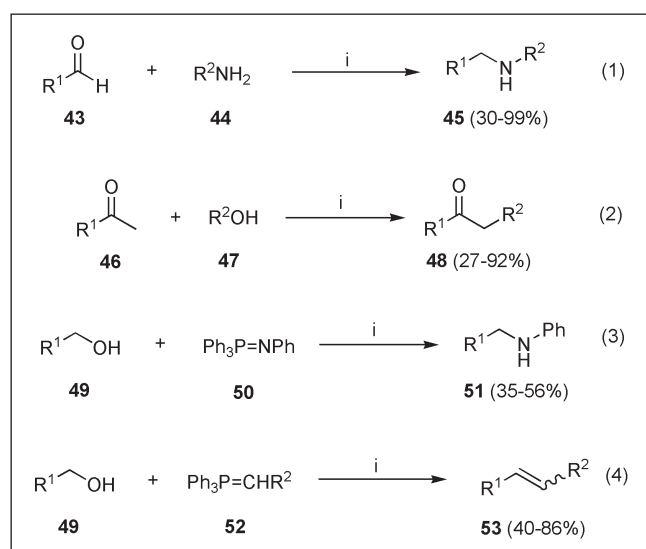

Fig. 7. Reagents: (i) NiCl₂, 2Li, DTBB (5%), solvent [PrOH reflux (1) or THF at room temperature (2) or at reflux (3), (4)].

- [4] Alonso F, Yus M (1997) Recent development in Barbier-type reactions. *Recent Res Dev Org Chem* 1:397-436
- [5] Alonso F, Ramón DJ, Yus M (1997) Reductive deprotection of allyl, benzyl and sulfonyl substituted alcohols, amines and amides using a naphthalene-catalysed lithiation. *Tetrahedron* 53:14355-14368
- [6] Alonso E, Yus M (1998) The $\text{NiCl}_2 \cdot 2\text{H}_2\text{O}$ -Li-arene (cat.) combination as reducing system. Part 3. Reduction of carbonyl compounds and imines. *Tetrahedron* 54:1921-1928
- [7] Alonso F, Radivoy G, Yus M (1999) Dehalogenation of organic halides using the $\text{NiCl}_2 \cdot 2\text{H}_2\text{O}$ -Li-DTBB (cat.) combination. *Tetrahedron* 55:4441-4444
- [8] Alonso F, Radivoy G, Yus M (2000) Reduction of hydrazines, azo and azoxy compounds, and amine *N*-oxides with the $\text{NiCl}_2 \cdot 2\text{H}_2\text{O}$ -Li-DTBB (cat.) combination. *Tetrahedron* 56:8673-8678
- [9] Alonso F, Radivoy G, Yus M (2001) Two new methodologies for the deoxygenation and reduction of nitrones based on the use of lithium and DTBB (cat.). *Synthesis* 427-430
- [10] Alonso F, Yus M (2001) The hydrogenation of cyclododecene by lithium naphthalenide and nickel chloride hydrate. *J Chem Educ* 78:1517-1518
- [11] Alonso F, Yus M (2001) The NiCl_2 -Li-arene (cat.) combination as reducing system. Part 8. Catalytic hydrogenation of organic compounds using the NiCl_2 -Li-arene (cat.) combination. *Adv Synth Catal* 343:188-191
- [12] Alonso F, Beletskaya IP, Yus M (2002) Metal-mediated reductive hydrodehalogenation of organic halides. *Chem Rev* 102: 4009-4091
- [13] Alonso F, Meléndez J, Yus M (2002) Synthesis of substituted 1,5-dioxaspiro[2.4]heptanes from 2,3-dichloroprop-1-ene. *Helv Chim Acta* 85:3262-3271
- [14] Alonso F, Candela P, Gómez C, Yus M (2003) The NiCl_2 -Li-arene (cat.) combination as reducing system. Part 9. Catalytic hydrogenation of organic compounds using the NiCl_2 -Li-(naphthalene or polymer-supported naphthalene) (cat.) combination. *Adv Synth Catal* 345:275-279
- [15] Alonso F, Lorenzo, E, Meléndez J, Yus M (2003) Straight and versatile synthesis of substituted perhydrofuro[2,3-*b*]pyrans from 2-chloromethyl-3-(2-methoxyethoxy)propene. *Tetrahedron* 59:5199-5208
- [16] Alonso F, Meléndez J, Yus M (2003) Dilithiated synthons: synthesis of cyclic ethers. *Russ Chem Bull* 52:2628-2635
- [17] Alonso F, Meléndez J, Yus M (2004) Straightforward synthesis of 1,7-dioxaspiro[4.1]nonanes. *Tetrahedron Lett* 45:1717-1720
- [18] Alonso F, Yus M (2004) The NiCl_2 -Li-arene combination: a versatile reducing mixture. *Chem Soc Rev* 33:284-293
- [19] Alonso F, Calvino JJ, Osante I, Yus M (2005) A new straightforward and mild preparation of nickel(0) nanoparticles. *Chem Lett* 34:1262-1263
- [20] Alonso F, Dacunha B, Meléndez J, Yus M (2005) Regioselective synthesis of 1,7-dioxaspiro[4.4]nonanes from a trimethylenemethane dianion synthons. *Tetrahedron* 61:3437-3450
- [21] Alonso F, Meléndez J, Yus M (2005) A new 3-methylidenepentane-1,5-dianion synthons: synthesis of perhydroprano[2,3-*b*]pyrans and 1,7-dioxaspiro[4.5]decanes. *Tetrahedron* 46:6519-6524
- [22] Alonso F, Moglie Y, Vitale C, Radivoy G, Yus M (2005) A new mild deprotecting method for *O*-benzylsulfonyl phenols and alcohols based on a DTBB-catalyzed lithiation. *Synthesis* 1971-1976
- [23] Alonso F, Calvino JJ, Osante I, Yus M (2006) Preparation of nickel(0) nanoparticles by arene-catalysed reduction of different nickel chloride-containing systems. *J Exp Nanosci* 1:419-433
- [24] Alonso F, Meléndez J, Soler T, Yus M (2006) A direct synthesis of 1,7-dioxaspiro[4.5]decanes from the new 3-methylidenepentane-1,5-dianion synthon. *Tetrahedron* 62:2264-2277
- [25] Alonso F, Meléndez J, Yus M (2006) Highly stereoselective synthesis of perhydroprano[2,3-*b*]pyrans from the new 3-methylidenepentane-1,5-dianion synthons. *Tetrahedron* 62:4814-4822
- [26] Alonso F, Osante I, Yus M (2006) Conjugate reduction of α , β -unsaturated carbonyl compounds promoted by nickel nanoparticles. *Synlett* 3017-3020
- [27] Alonso F, Osante I, Yus M (2006) Highly stereoselective semihydrogenation of alkynes promoted by nickel(0) nanoparticles. *Adv Synth Catal* 348:305-308
- [28] Alonso F, Foubelo F, Yus M (2007) 1,5-Dioxaspiro[2.4]heptanes. *Curr Chem Biol* 1:317-346
- [29] Alonso F, Osante I, Yus M (2007) Highly selective hydrogenation of multiple carbon-carbon bonds promoted by nickel(0) nanoparticles. *Tetrahedron* 63:93-102
- [30] Alonso F, Riente P, Yus M (2007) The α -alkylation of methyl ketones with primary alcohols promoted by nickel nanoparticles under mild and ligandless conditions. *Synlett* 1877-1880
- [31] Alonso F, Riente P, Yus M (2008) Alcohols for the α -alkylation of methyl ketones and indirect aza-Wittig reaction promoted by nickel nanoparticles. *Eur J Org Chem* 4908-4914
- [32] Alonso F, Riente P, Yus M (2008) Homocoupling of aryl iodides promoted by nickel nanoparticles. *Arkivoc* iv:8-15
- [33] Alonso F, Riente P, Yus M (2008) Hydrogen-transfer amination of aldehydes. *Synlett* 1289-1292
- [34] Alonso F, Riente P, Yus M (2008) Hydrogen-transfer reduction of carbonyl compounds catalysed by nickel nanoparticles. *Tetrahedron Lett* 49:1939-1942
- [35] Alonso F, Riente P, Yus M (2008) Hydrogen-transfer reduction of carbonyl compounds promoted by nickel nanoparticles. *Tetrahedron* 64:1847-1852
- [36] Alonso F, Yus M (2008) New synthetic methodologies based on active transition metals. *Pure Appl Chem* 80:1005-1012
- [37] Alonso F, Riente P, Yus M (2009) Transfer hydrogenation of olefins catalysed by nickel nanoparticles. *Tetrahedron* 65:10637-10643
- [38] Alonso F, Riente P, Yus M (2009) Wittig-type olefination of alcohols promoted by nickel nanoparticles: synthesis of polymethoxylated and polyhydroxylated stilbenes. *Eur J Org Chem* 6034-6042

- [39] Behloul C, Guijarro D, Yus M (2005) Deallyloxy- and de-benzyloxy-carbonylation of protected alcohols, amines and thiols via a naphthalene-catalysed lithiation reaction. *Tetrahedron* 61:9319-9324
- [40] Behloul C, Guijarro D, Yus M (2006) Deacylation of esters, thioesters and amides by a naphthalene-catalysed lithiation. *Synthesis* 309-314
- [41] Behloul C, Guijarro D, Yus M (2004) Detritylation of *N*-tritylamines via a naphthalene-catalysed lithiation process. *Synthesis* 1274-1280
- [42] Behloul C, Guijarro D, Yus M (2005) Desilylation procedure via a naphthalene-catalysed lithiation reaction. *Tetrahedron* 61:6908-6915
- [43] Chinchilla R, Nájera C, Yus M (2005) Functionalized organolithium compounds in total synthesis. *Tetrahedron* 61:3139-3176
- [44] Clayden J (2002) *Organolithiums: selectivity for synthesis*. Pergamon, Oxford
- [45] Cohen T, Bhupathy M (1989) Organoalkali compounds by radical anion induced reductive metalation of phenyl thioethers. *Acc Chem Res* 22:152-161
- [46] Foubelo F, Yus M (2005) Organodilithium intermediates as useful dianionic synthons: recent advances. *Curr Org Chem* 9:459-490
- [47] Foubelo F, Yus M (2008) Functionalised organolithium compounds by sulphur-lithium exchange. *Chem Soc Rev* 37:2620-2633
- [48] Guijarro D, Yus M (1998) Non-deprotonating methodologies for organolithium reagents starting from non-halogenated materials. *Recent Res Devel Org Chem* 2:713-744
- [49] Guillena G, Ramón DJ, Yus M (2007) Alcohols as electrophiles in C-C bond forming reactions: the hydrogen autotransfer processes. *Angew Chem Int Ed* 46:2358-2364
- [50] Hogan AML, O'Shea DF (2008) Synthetic applications of carbolithiation transformations. *Chem Commun* 3839-3851
- [51] Meléndez J, Alonso F, Yus M (2006) Straightforward synthesis of 1,6-dioxaspiro[4.4]nonanes. *Tetrahedron Lett* 47:1187-1191
- [52] Melero C, Herrera RP, Guijarro A, Yus M (2007) New modes of reactivity in the threshold of the reduction potential in solution. Alkylation of lithium PAH (polycyclic aromatic hydrocarbon) dianions by primary fluoroalkanes: a reaction pathway complementing the classical Birch reductive alkylation. *Chem Eur J* 13:10096-10107
- [53] Melero C, Guijarro A, Yus M (2009) Structural characterization and bonding properties of lithium naphthalene radical anion, $[\text{Li}^+(\text{TMEDA})_2][\text{C}_{10}\text{H}_8^-]$, and lithium naphthalene dianion $[(\text{Li}^+\text{TMEDA})_2\text{C}_{10}\text{H}_8^{2-}]$. *Dalton Trans* 28:1286-1289
- [54] Nájera C, Sansano JM, Yus M (2003) Recent synthetic uses of functionalised aromatic and heteroaromatic organolithium reagents prepared by non-deprotonating methods. *Tetrahedron* 59:9255-9303
- [55] Najera C, Yus M (2003) Functionalized organolithium compounds: New synthetic adventures. *Curr Org Chem* 7:867-926
- [56] Pastor IM, Peñafiel I, Yus M (2008) Easy selective generation of (lithiomethyl)cyclopropane or homoallyllithium by a chlorine-lithium exchange *Tetrahedron Lett* 49:6870-6872
- [57] Radivoy G, Alonso F, Yus M (1999) Reduction of sulfonates and aromatic compounds with the $\text{NiCl}_2 \cdot 2\text{H}_2\text{O}$ -Li-arene (cat.) combination. *Tetrahedron* 55:14479-14490
- [58] Ramón DJ, Yus M (2000) New methodologies based on arene-catalyzed lithiation reactions and their application to synthetic organic chemistry. *Eur J Org Chem* 225-237
- [59] Rappoport Z, Marek I (eds) (2004) *The chemistry of organolithium compounds*. Wiley, Chichester
- [60] Screttas CG, Micha-Screttas M (1978) Hydrolithiation of alpha-olefins by a regioespecific two-step process. Transformation of alkyl sulfides to alkyllithium reagents *J Org Chem* 43:1064-1071
- [61] Yus M (1996) Arene-catalysed lithiation reactions. *Chem Soc Rev* 25:155-161
- [62] Yus M, Foubelo F (1997) Reductive opening of saturated oxa-, aza- and thia-cycles by means of an arene-promoted lithiation: synthetic applications. *Rev Heteroatom Chem* 17:73-107
- [63] Yus M (2001) From arene-catalyzed lithiation to other synthetic adventures. *Synlett* 1197-1205
- [64] Yus M, Ortiz R, Huerta FF (2002) DTBB-catalysed lithiation of 6-chloro-1-hexene and related systems: synthetically useful temperature-dependent behaviour. *Tetrahedron Lett* 43:2957-2960
- [65] Yus M (2003) Ring opening of heterocycles by an arene-catalyzed lithiation. *Pure Appl Chem* 75:1453-1475
- [66] Yus M, Behloul C, Guijarro, D (2003) Detritylation procedure under non-acidic conditions: naphthalene catalysed reductive cleavage of trityl ethers. *Synthesis* 2179-2185
- [67] Yus M, Ortiz R, Huerta FF (2003) Intramolecular carbolithiation promoted by a DTBB-catalysed chlorine-lithium exchange. *Tetrahedron* 59:8525-8542

About the author

Miguel Yus graduated in Chemistry (1969) and defended his Ph.D. thesis (1973) at the University of Zaragoza. After two years as a postdoctoral researcher in the Max Planck Institute of Mülheim

(Germany), he joined the University of Oviedo, where he became Adjunct Professor (1977) and then full Professor (1987). In 1988, he moved to the University of Alacant (*Sp.* Alicante) as Professor of Organic Chemistry. He is currently Director of the Institute for Organic Synthe-

sis. Dr. Yus has coauthored more than 500 papers, supervised around 50 Ph.D. students, and delivered more than 150 lectures abroad. In 2002, he founded the company MEDALCHEMY S. L. to commercialize fine chemicals.