

# Metal complexation by electroanalytical techniques: hard- and soft-modelling approaches

Miquel Esteban\*, Cristina Ariño and José Manuel Díaz-Cruz

Departament de Química Analítica, Universitat de Barcelona

## Abstract

Two general approaches are used to investigate metal complexation by electrochemical tools. The first one, *hard-modelling*, is based on the postulation of a theoretical physico-chemical model for both the electrode reaction and complexation processes, and its further analytical or numerical resolution. Later, the fitting of the parameters of that model to the experimental data provides the information about metal complexation. The second approach, *soft-modelling*, involves the identification of a complexation model from the numerical and statistical analysis of data, without any previous assumption of a model. This approach has been extensively applied to spectroscopic data, but very rarely used with electrochemical results.

In this article we deal with the formulation of a model (*hard-modelling*) for metal complexation in mixed-ligand systems, including macromolecular ligands, and with the application of the *soft-modelling* technique designated 'Multivariate Curve Resolution by Alternating Least Squares' to several systems of biological and environmental interest.

**Keywords:** Metal speciation, complexation, hard-modelling, soft-modelling, voltammetry.

## Resum

En la investigació de la complexació de metalls mitjançant eines electroanalítiques són emprades dues aproximacions generals. La primera, anomenada *de modelatge dur (hard-modelling)*, es basa en la formulació d'un model fisicoquímic conjunt per als processos electròdic i de complexació i en la resolució analítica o numèrica del model. Posteriorment, l'ajust dels paràmetres del model a les dades experimentals donarà la informació desitjada sobre el procés de complexació. La segona aproximació, anomenada *de modelatge tou (soft-modelling)*, es basa en la identificació d'un model de complexació a partir de l'anàlisi numèrica i estadística de les dades, sense cap assumptió prèvia d'un model. Aquesta aproximació, que ha estat extensivament emprada amb dades espectroscòpiques, ho ha estat poquíssim amb dades electroquímiques.

En aquest article tractem de la formulació d'un model (*hard-modelling*) per a la complexació de metalls en sistemes amb mesclades de lligands, incloent-hi lligands macromoleculars, i de l'aplicació de la tècnica (*soft-modelling*) anomenada *resolució multivariant de corbes per mínims quadrats alternants* a diversos sistemes d'interès biològic i ambiental.

Chemical speciation is defined as the distribution of an individual chemical element between different chemical species or groups of species [1]. In natural aquatic systems it reflects the chemical complexity of these media. Substantial progress has been made over recent years in chemical speciation and in the understanding of metal interactions with aquatic organisms, which are crucial issues owing to their intimate relationships with bioavailability and toxicity. In early studies, designed to measure trace metal toxicity, met-

al solution chemistry was generally overlooked. However, more recent work has stressed the importance of metal solution equilibria in controlling chemical speciation in the exposure medium external to organisms [1].

Metal complexation equilibria and speciation have been classical subjects of electroanalytical techniques, especially potentiometry and voltammetry. In recent years, interest in this subject has been renewed because of the increasing focus of Analytical Chemistry on metal speciation over total metal concentration determination. As mentioned previously, this is because the direct relationship of metal speciation with bioavailability and biouptake by microorganisms.

In recent years several dynamic, *in situ* speciation techniques have been developed for routine use, although they

\* Author for correspondence: Miquel Esteban, Departament de Química Analítica, Facultat de Química, Universitat de Barcelona. Martí i Franquès 1 – 10, 08028-Barcelona, Catalonia (Spain). Tel. 34 934021277. Fax: 34 934021233. Email: miquel.esteban@apolo.qui.ub.es

are still in an incipient stage. These techniques include GIME (Gel Integrated Microelectrode), DGT (Diffusive Gradients in Thin-films), PLM (Permeation Liquid Membrane) and DMT (Donnan Membrane Technique).

An additional advantage of electroanalytical techniques, mainly voltammetry, is the similarity between metal biouptake in biological membranes and the reduction of metal species in an electrode process. This has resulted in the

use of voltammetric devices as simpler models for natural processes (Figure 1). In order to increase the similarity between the model electrode systems and natural ones, new trends in voltammetric sensors combine micro- or ultramicroelectrodes with permeation liquid membranes PLM or gels (GIME), Gel Integrated Microelectrodes, the aim being to study the dynamics of metal biouptake. In such voltammetric sensors the understanding of the relative role of the

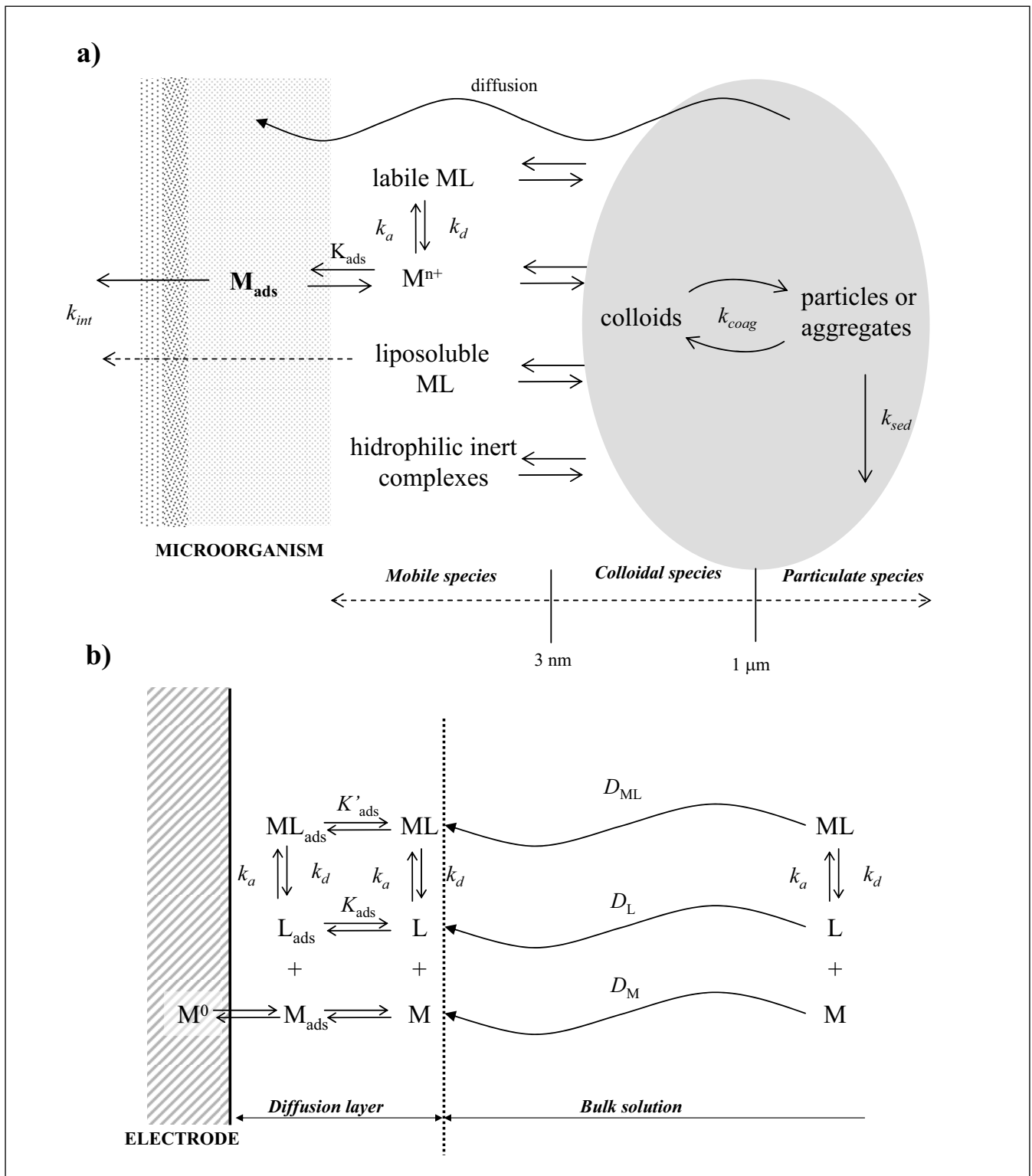

Figure 1. Schematic representations of the principal reactions of a complex ML at a living particle (a), and at an electrode (b).

many factors affecting the measurement is very important and complex. In fact, the development of concepts and numerical models for predicting the effects of these factors on metal uptake by microorganisms is crucial for the future use of such devices, and of speciation in aquatic systems.

In all cases, for the proper data interpretation of simple electrode systems or integrated devices, there is an urgent need for sound theoretical studies of voltammetry in metal complex systems, especially those including natural, heterogeneous, macromolecular ligands.

#### Voltammetry in metal complexation: hard-modelling approach

When metal ions in solution undergo complexation with ligands, their voltammetric reduction signals can be modified in different ways, depending on the characteristics of both the ligand and the electrochemical process (Fig. 2).

In the case of an electrochemically inert complex, it practically does not dissociate within the timescale of the voltammetric measurement. Consequently, the linear contribution of the present species to the current can be assumed, since the free metal and the complex(es) diffuse independently towards the electrode (i.e. without conversion into each other) and the system behaves like any other multianalyte system. Thus, the total current for every potential is equal to the sum of the current contribution of the species, which are proportional to the respective bulk concentrations. This feature produces two (or more) separate signals. The first one, with the same half-wave or peak potential as in the absence of ligand, is due to the reduction of free metal ion. The second (or higher) one is due to the reduction of the complex(es). In most cases its half-wave or peak potential is more negative than that of the free metal because, usually, complexation stabilises the oxidised form of the metal as compared to the reduced form, although this is not always true. In some cases, such stabilisation is so important that the complex cannot be reduced inside the available potential window and does not produce any signal. This behaviour is illustrated by Fig. 2a.

In the case of electrochemically labile complexes, their association-dissociation kinetics are much faster than the voltammetric measurement. Consequently, linearity is not always fulfilled, because the free metal and the complexes are converting one into the other as they diffuse towards the electrode. In this case the total current for every potential is not the sum of the current that would be obtained separately for several species with very slow kinetics. Indeed, only one signal is expected, with a half-wave or peak potential progressively shifting (from the values in the absence of ligand) towards more negative values as the metal complexation evolves. As diffusion coefficients of simple ligands are very close to those of metal ions ( $D_L \approx D_M$ ), there are no significant changes in the currents (Fig. 2b).

The more classical methods of Lingane [2], DeFord-Hume [3] and Schaap-McMasters [4] were proposed for the determination of the stability constants of a single complex,

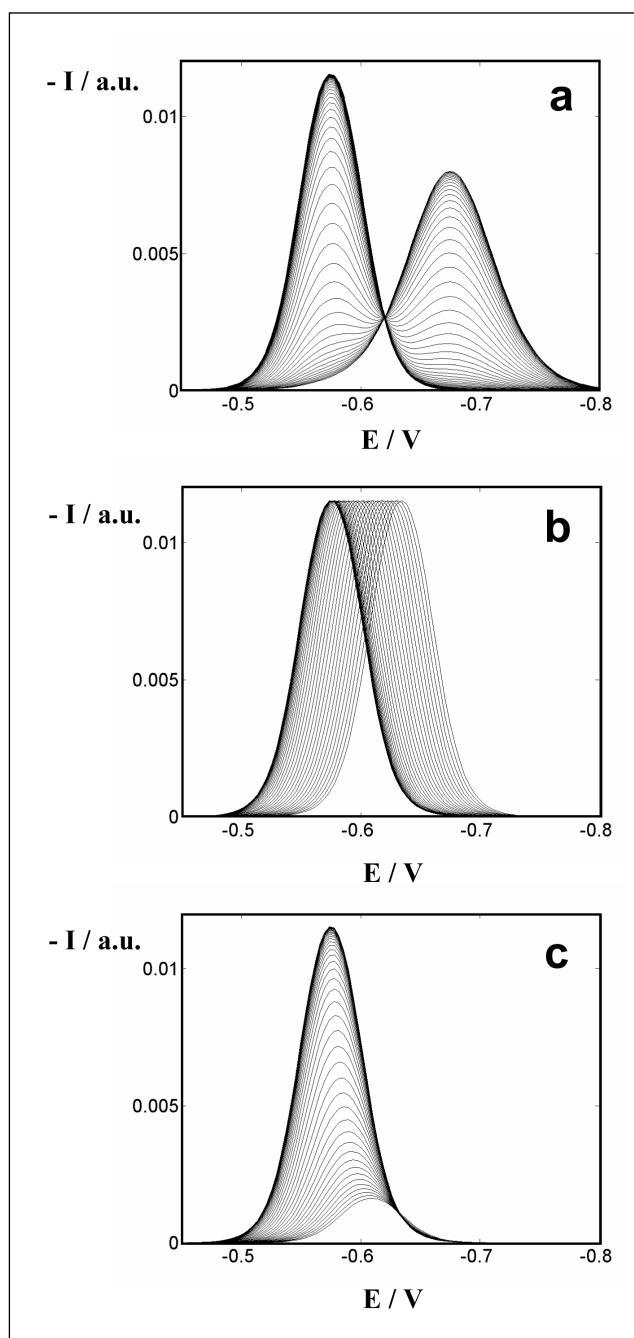

Figure 2. Simulated DPP data for a solution containing  $10^{-5} \text{ mol l}^{-1}$  of metal ion in the presence of a ligand concentration ranging from 0 to  $5 \times 10^{-3} \text{ mol l}^{-1}$  producing a 1:1 complex with stability constant  $\log K = 5.0$  and half-wave potential for the reversible reduction of the metal  $E_M = -0.6 \text{ V}$ .

- a) electrochemically inert system with an irreversible reduction ( $\alpha = 0.6$ ) of the complex at a half wave potential of  $E_{ML} = -0.7 \text{ V}$ , and assuming  $D_{ML} = D_M$ ;  
 b) electrochemically labile system with  $D_{ML} = D_M$ ;  
 c) electrochemically labile system with  $D_{ML} < D_M$  ( $\epsilon = D_{ML}/D_M = 0.01$ ).

consecutive complexes and consecutive complexes in mixed ligand systems, respectively, but restricted to  $D_L \approx D_M$ . These methods simultaneously correlate potential shifts and current variations with stability constants, but, because of the minor contribution of current variations, potential shifts are the major contribution. More recently, Cukrowski [5] proposed a method that, using similar equations to DeFord-

Hume and mass-balance equations, allows the speciation for labile metal-ligand systems. For those cases where the ligand is reduced more easily than the metal ion, Casassas and Eek [6] developed a method based on the potential shift of the ligand.

The case of heterogeneous and non-fully defined macromolecular ligands, with  $D_L < D_M$ , is especially interesting due to their environmental or biological relevance. Kacena and Matousek [7] examined the homogeneous case with  $D_L < D_M$  proposing a mean diffusion coefficient that depends on the stability constant of the complex. More recently, de Jong *et al.* [8–10] revisited the problem by proposing a more general treatment, which has proved to be very useful in the study of metal ion – macromolecule interactions [11]. As diffusion coefficients of metal and ligand are quite different, remarkable changes in the currents are apparent (Fig. 2c).

#### Alternative approaches: soft modelling applied to voltammetric data

In all cases mentioned above, methods are based on a physico-chemical formulation of the electrochemical and complexation processes and further mathematical (analytical or numerical) analysis. This approach, the more usual in electrochemistry, can be designated *hard-modelling*. However, in many cases the postulation of a theoretical physico-chemical model is very difficult because the electrode process, the complexation process or both are rather involved. In such cases, other type of approach is needed.

An alternative approach is *soft-modelling*, which involves the identification of a chemical model from numerical and statistical analysis of a data set, instead of fitting of an assumed external theoretical model to the experimental data. This approach has emerged as a consequence of the explosive growth of chemometrics in recent years. Although much progress has been made in applying chemometrics to electroanalytical determinations, their use has been mainly orientated towards the simultaneous quantitative determination of mixtures of analytes giving highly overlapping signals [12]. However, application of chemometrics to voltammetric data with the aim of resolving metal complex equilibria is recent and remains rather scarce [13]. This is in contrast to spectroscopical data, which have been widely used, mainly through factor analysis techniques [14–16].

In the present contribution, we offer a general overview of the more recent contributions of the authors' group concerning: *i*) voltammetry of metal complexation by macromolecular ligands, based on hard-modelling approaches; *ii*) the development and application of new methods based on soft-modelling approaches.

#### Hard modelling in the complexation by macromolecular ligands

As mentioned above, de Jong *et al.* [8–10] proposed a rigorous model for the voltammetry of metal – ligand systems when the ligand has a much smaller diffusion coefficient

than that of the metal ion, and by assuming lack of electrode adsorption. This model is a simplification of a more general case (Fig. 1b), that is closer to the actual situation, but it is of great interest when: *i*) adsorption can be experimentally minimised, and then neglected; and *ii*) as the basis of more complex approaches including either adsorption, effect of the metal-to-ligand concentration ratio, or mixed ligand complexation.

Recently, we have extended the model of de Jong *et al.* [8–10] for the voltammetry of metal ions in mixtures of macromolecular and simple ligands, which is a very common situation in natural systems.

The proposed model [17] considers the reversible reduction of a metal ion  $M$  on the mercury electrode in the presence of a mixture of ligands  $L_i$  forming electroinactive metal complexes. Such ligands can be simple (small molecules or ions) or macromolecular (containing many sites of different types or many sites of the same type). This can be summarised as:

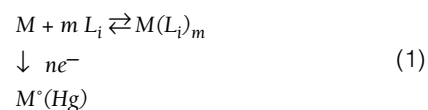

(electrical charges have been omitted for the sake of simplicity).

The model also considers the following hypothesis:

- Absence of electrode adsorption.
- Excess of all complexing sites in the ligands with respect to  $M$ .
- In the time scale of the voltammetric measurement, complexes are totally labile or totally inert.
- Each ligand produces only (voltammetrically) labile complexes or (voltammetrically) inert complexes.
- Prior to any voltammetric measurement, all the metal species are in equilibrium (even in the case of voltammetrically inert complexes).
- Absence of mixed-ligand or polynuclear complexes.
- Plane electrode (drop radius > width of the diffusion layer).
- For each drop, a constant potential is applied during the faradaic process.

Hypothesis b) guarantees that the concentration of each ligand at any distance from the electrode ( $x$ ) and at any time ( $t$ ) will be equal to the concentration in the bulk solution.

After the consideration of the complexation and the establishment of the diffusion of the species towards the electrode, the system of differential equations is properly solved, and the following equation is obtained:

$$F_0 \equiv \exp\left(-\frac{nF}{RT} \Delta E - \ln \phi\right) = \frac{C_{M, total}^*}{C_M^*} = 1 + \sum_{i,m} \beta_{i,m} (C_{Li}^*)^m \quad (2)$$

where  $\Delta E$  is the potential shift caused by the addition of the ligands to the metal ion alone,

$$\beta_{i,m}^* = \frac{c_{M(L_i)_m}^*}{c_M^* (c_{L_i}^*)^m} \quad (3)$$

$$C_{M,total}^* = C_{M,labile}^* + C_{M,inert}^* = C_M^* \left( 1 + \sum_{i,m} \beta_{i,m}^* (C_{L_i}^*)^m \right) \quad (4)$$

$$C_{M,inert}^* = C_M^* + \sum_{i,m,inert} C_{M(L_i)_m}^* = C_M^* \sum_{i,m,inert} \beta_{i,m}^* (C_{L_i}^*)^m \quad (5)$$

$$C_{M,labile}^* = C_M^* + \sum_{i,m,labile} C_{M(L_i)_m}^* = C_M^* \sum_{i,m,labile} \beta_{i,m}^* (C_{L_i}^*)^m \quad (6)$$

the normalised current  $\phi$  is defined as [8-10]:

$$\phi = \frac{I_{lim}(\text{presence } L_i)}{I_{lim}(\text{absence } L_i)} = \sqrt{\frac{\bar{D}}{D_M}} \frac{c_{M,labile}^*}{c_{M,total}^*} \quad (7)$$

the mean diffusion coefficient as:

$$\bar{D} = \frac{D_M c_M + \sum_{i,m,labile} D_i c_{M(L_i)_m}}{c_{M,labile}} \quad (8)$$

and ratio  $\varepsilon$  between diffusion coefficients as:

$$\varepsilon_i = D_i / D_M \quad (9)$$

where  $D_M$  and  $D_i$  respectively indicate the diffusion coefficient of the free metal and the complex  $M(L_i)_m$  (assumed to be independent of  $m$ ). Then, the normalised current  $\phi$  can be rewritten as:

$$\phi = \frac{\sqrt{\left(1 + \sum_{i,m,labile} \varepsilon_i \beta_{i,m}^* (c_{L_i}^*)^m\right) \left(1 + \sum_{i,m,labile} \beta_{i,m}^* (c_{L_i}^*)^m\right)}}{1 + \sum_{i,m} \beta_{i,m}^* (c_{L_i}^*)^m} \quad (10)$$

It should be pointed out that all the equations above have been deduced by assuming a constant potential for each drop (hypothesis h), so that, in principle, they are applicable only to techniques such as direct current polarography (DCP) and normal pulse polarography (NPP). However, we propose that these equations, which use normalised parameters for currents and potentials, are also valid for reverse pulse polarography (RPP) and differential pulse polarography (DPP), techniques more interesting due to the minimisation of electrode adsorption and the better detection limits, respectively.

Although the general formulation of the model does not take into account the formation of mixed complexes, it would be possible to include this point with some restrictions:

- Mixed complexes with one or more "inert" ligands are inert. The rest are labile.
- Mixed complexes have a diffusion coefficient close to that of the largest ligand.

For these mixed complexes it is possible to write the equilibrium:

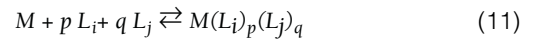

described through the mixed complexation constant:

$$\beta_{ij}^{pq} = \frac{c_{M(L_i)_p(L_j)_q}^*}{c_M^* (c_{L_i}^*)^p (c_{L_j}^*)^q} \quad (12)$$

In this way, it is possible to obtain general expressions from equations (10) and (2):

$$\phi = \frac{1}{1 + \sum_{i,m} \beta_{i,m}^* (C_{L_i}^*)^m + \sum_{i \neq j, p, q} \beta_{ij}^{pq} (C_{L_i}^*)^p (C_{L_j}^*)^q} \left\{ \left( 1 + \sum_{i,m,labile} \varepsilon_i \beta_{i,m}^* (C_{L_i}^*)^m + \sum_{i \neq j, p, q, labile} \varepsilon_{ij} \beta_{ij}^{pq} (C_{L_i}^*)^p (C_{L_j}^*)^q \right) \right. \\ \left. \cdot \left( 1 + \sum_{i,m,labile} \beta_{i,m}^* (C_{L_i}^*)^m + \sum_{i \neq j, p, q, labile} \beta_{ij}^{pq} (C_{L_i}^*)^p (C_{L_j}^*)^q \right)^{1/2} \right\} \quad (13)$$

$$F_0 \equiv \exp\left(-\frac{nF}{RT} \Delta E - \ln \phi\right) = \frac{C_{M,total}^*}{C_M^*} = 1 + \sum_{i,m} \beta_{i,m}^* (C_{L_i}^*)^m + \sum_{i \neq j, p, q} \beta_{ij}^{pq} (C_{L_i}^*)^p (C_{L_j}^*)^q \quad (14)$$

To assess the validity of the general method described above, several systems have been studied, which correspond to different situations that can be considered as particular cases of the general one [18 – 22].

Figure 3 shows some of the results expected according to equations (13) and (14) for the voltammetric titration of a metal ion with some characteristic mixtures of ligands, whilst Figure 4 show some experimental results from which satisfactory average stability constants  $K$  were evaluated. Several experimental cases, which are representative of some

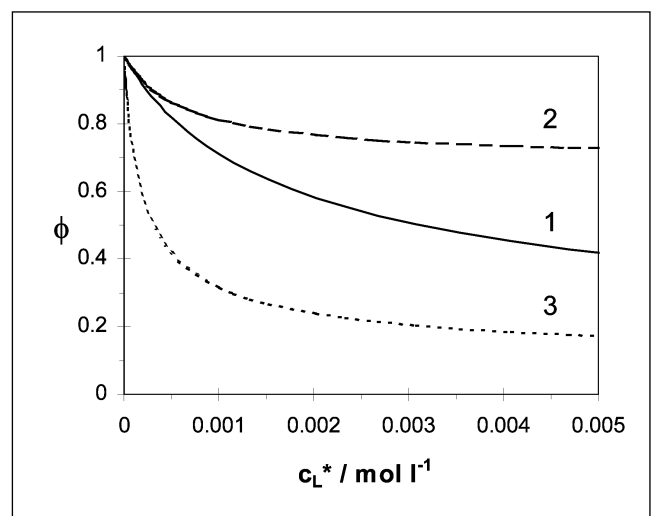

Figure 3. Simulated normalised current ( $\phi$ ) as a function of the total ligand concentration ( $c_L^*$ ) for a mixture of 10% macromolecular ligand ( $\varepsilon = 0.01$ ,  $\log K = 4.0$ ) and 90 % simple labile ligand ( $\varepsilon = 1.0$ ,  $\log K = 3.0$ ) including formation of a 1:1:1 mixed complex of stability constant  $\log K_{mix} = 7.0$  ( $\varepsilon = 0.01$ ). (Titration with the mixture of ligands in the presence (1) or the absence (2) of the mixed complex; titration with the macromolecular ligand only (3)).

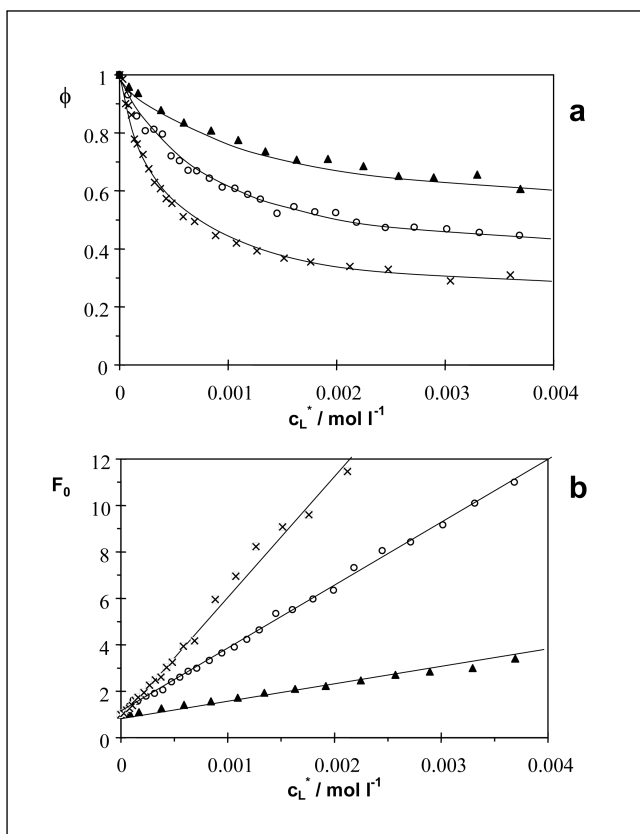

Figure 4.  $\phi$  vs.  $c_L^*$  (a) and  $F_0$  vs.  $c_L^*$  (b) plots obtained in RPP titrations of solutions containing  $1.0 \times 10^{-5} \text{ mol l}^{-1}$  of Cd(II) and  $0.1 \text{ mol l}^{-1}$  of  $\text{KNO}_3$  with solutions containing PMA (dissociation degree  $\alpha_d = 0.6$ ) and  $\text{Br}^-$  at pH 6.5. The solutions added had different molar ratios of PMA :  $\text{Br}^-$ , i.e. 1:10 ( $\blacktriangle$ ), 5:5 (O), 1:0 ( $\times$ ).

model situations, have been satisfactorily investigated. The cases studied are summarized in Table 1.

The model by de Jong *et al.* [8 – 10] has been enhanced in order to consider the electrode adsorption of the ligand and the induced adsorption of the metal. This is a very common situation for macromolecular ligands with ionisable functional groups that cannot always be avoided through the control of the experimental variables, especially the applied potential. In a first approach, the case of electrochemically labile complexation and excess ligand (with respect to the metal) was considered [23 –26]. Later, the more complex, and general, case assuming any ligand-to-metal ratio was analysed [27 – 30], with special attention to techniques such

as Normal Pulse Polarography NPP and Reverse Pulse Polarography RPP, and the influence of adsorption on the calibration plots.

The case of RPP is especially interesting because it has been extensively demonstrated to avoid adsorption effects in the limiting current [29, 31, 32]. Indeed, under excess ligand conditions, limiting RPP currents are free of any adsorption influence [29]. This result also holds for any ligand-to-metal ratio if there is no ligand adsorption [28].

Heterogeneity of macromolecular complex systems can be studied by voltammetric or potentiometric techniques [33, 34]. From the combined use of RPP and potentiometric titrations, we have recently proposed a method to obtain the metal binding curves (i.e., the fraction of occupied complexing sites vs. free metal concentration) of heterogeneous natural macromolecular ligands such as fulvics and humics [34]. Thus, acid-base potentiometric titrations of fulvic acid solutions allow the initial charge of fulvic acid to be determined. RPP titrations of fulvic acid with metal ions are interpreted on the basis of the NICCA-Donnan model [35 – 37].

In the NICCA-Donnan model, the interactions between ions and humic matter are classified as specific binding (intrinsic affinity) and non-specific binding (coulombic interactions). The basic NICCA equation for the overall binding of species  $i$  in the competitive situation for a bimodal distribution [36] encompassing binding sites with a low affinity ( $l = 1$ ) or with a high affinity ( $l = 2$ ) distribution is:

$$Q_1 = \sum_{l=1}^2 Q_{\max,H,l} \frac{n_{i,l} (\bar{k}_{i,l} c_{D,i})^{n_{i,l}} \left( \sum_j (\bar{k}_{j,l} c_{D,j})^{n_{j,l}} \right)^{p_l}}{n_{H,l} \sum_j (\bar{k}_{j,l} c_{D,j})^{n_{j,l}} + \left( \sum_j (\bar{k}_{j,l} c_{D,j})^{n_{j,l}} \right)^{p_l}} \quad (15)$$

where  $Q_i$  and  $Q_{\max,H,l}$  are the bound amount of  $i$  and the maximum amount of  $l$ -type sites for proton binding, respectively, both expressed in  $\text{mol kg}^{-1}$ ;  $\bar{k}_{i,l}$  is the mean value of the  $l$ th affinity distribution,  $n_{i,l}$  is the specific non-ideality parameter seen by each particular ion  $i$ ;  $p_l$  is the generic heterogeneity parameter representative of the humic matter surface, and  $c_{D,i}$  is the concentration in the model Donnan phase (eqn. 18).

In potentiometric acid-base titrations, where essentially

Table 1. Summary of the different metal complex systems studied by the recently proposed voltammetric model (refs. [17] – [21])

Model system	Experimental case (examples)
Systems with 1:1 labile complexes.	Zn/PMA/Phthalate Cd/PMA/ $\text{Br}^-$
Systems with 1:m labile complexes with the simple ligand and 1:1 labile macromolecular complexes	Cd/PMA/ $\text{I}^-$
Systems with a mixture of labile and inert 1:1 complexes	Zn/ $\lambda$ -carrageenan/NTA
Systems with an insoluble compound (inert)	Zn/oxalate
Systems with a mixture of 1:1 labile and inert complexes, in absence of an excess of ligand	Zn/PMA/NTA.
(PMA, polymethacrylic acid; NTA, nitrilotriacetic acid)	

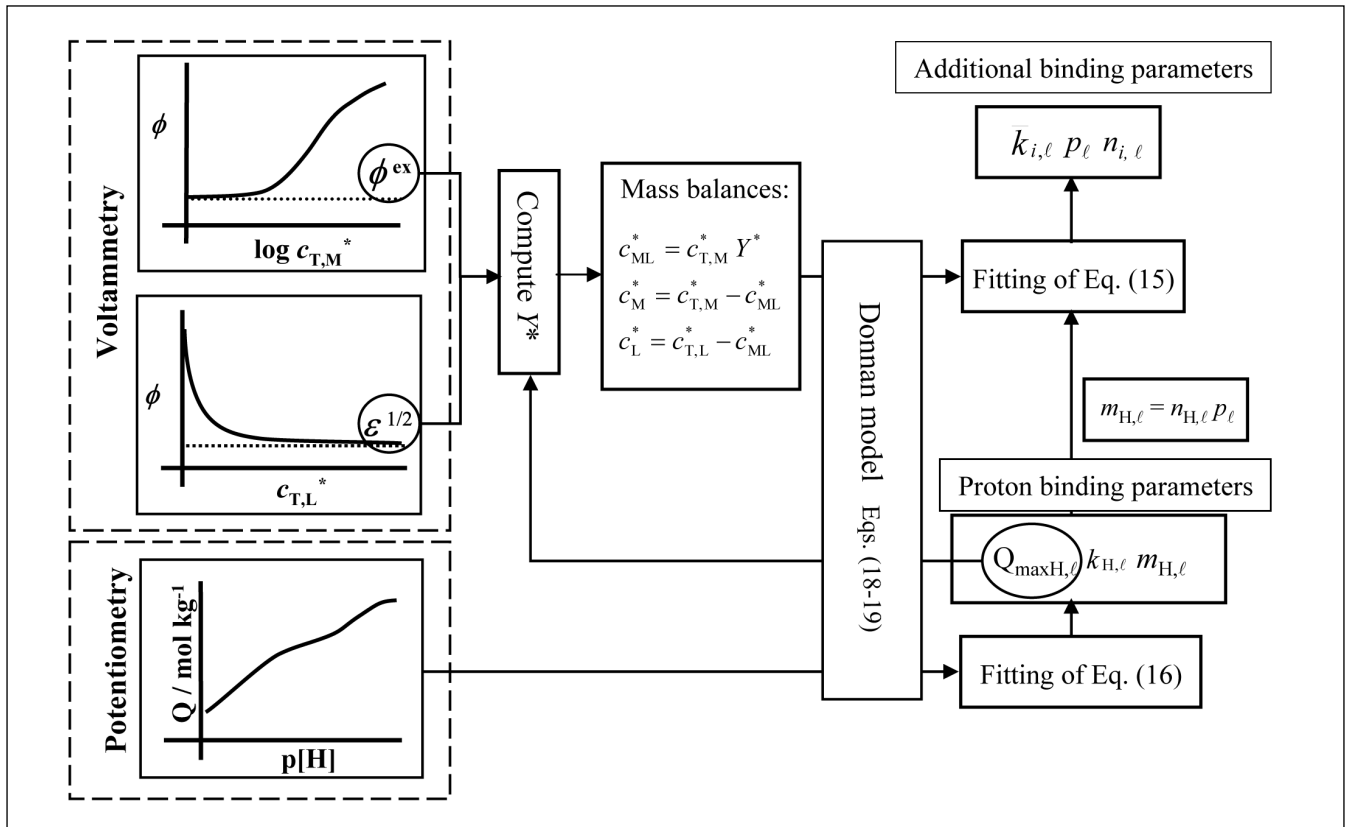

Figure 5. Diagram of the procedure for simultaneous voltammetric and potentiometric data analysis on labile heterogeneous complexation. The difference between  $Q_{\max H}$  and  $c_{TL}^*$  is in the units:  $\text{mol kg}^{-1}$  and  $\text{mol l}^{-1}$ , respectively.

only protons are involved, the NICCA model becomes a bi-modal Langmuir-Freundlich (L-F) isotherm, given by:

$$Q_H = Q_{\max H,1} \frac{(\bar{k}_{H,1} c_{D,H})^{m_{H,1}}}{1 + (\bar{k}_{H,1} c_{D,H})^{m_{H,1}}} + Q_{\max H,2} \frac{(\bar{k}_{H,2} c_{D,H})^{m_{H,2}}}{1 + (\bar{k}_{H,2} c_{D,H})^{m_{H,2}}} \quad (16)$$

where  $m_{H,l}$  is the overall non-ideality parameter for the  $l$ th kind of site seen by the proton and is related to the other parameters, as  $m_{H,l} = n_{H,l} p_l$ . Therefore, metal ion binding data are needed to split the apparent heterogeneity into the generic and the intrinsic heterogeneities. The affinity distribution associated with each L-F isotherm has the shape of a Sips distribution [38], and it is given as a logarithmic representation for each  $l$ th kind of site

$$\log k = \sum_{l=1}^2 \frac{Q_{\max H,l}}{Q_{\max H}} \left\{ \frac{\ln(10) \sin(\pi m_{H,l})}{\pi [2 \cos(\pi m_{H,l}) + 10^{m_{H,l}(\log k - \log \bar{k}_{H,l})} + 10^{m_{H,l}(\log \bar{k}_{H,l} - \log k)}]} \right\} \quad (17)$$

where  $Q_{\max H} = Q_{\max H,1} + Q_{\max H,2}$ .

The Donnan model correction yields the concentration of each ion in the permeable gel phase,  $c_{D,i}$ , which is calculated from the bulk concentration ( $c_i^*$ ) and the Boltzmann factor as:

$$c_{D,i} = c_i^* \exp\left(\frac{-z_i F \psi_D}{RT}\right) \quad (18)$$

where  $\psi_D$  is the Donnan potential (V),  $F$  is the Faraday con-

stant ( $C \text{ mol}^{-1}$ ),  $R$  is the gas constant ( $J \text{ mol}^{-1} K^{-1}$ ), and  $T$  is the temperature (K). The Boltzmann factor is computed from the electroneutrality condition for a gel with a negative structural site density [36]

$$Q/V_D + \sum_i z_i (c_{D,i} - c_i^*) = 0 \quad (19)$$

where  $V_D$  is the Donnan volume ( $L \text{ kg}^{-1}$ ), which is assumed to depend on the ionic strength only [36] and  $Q$  is the net charge of the fulvic substance.

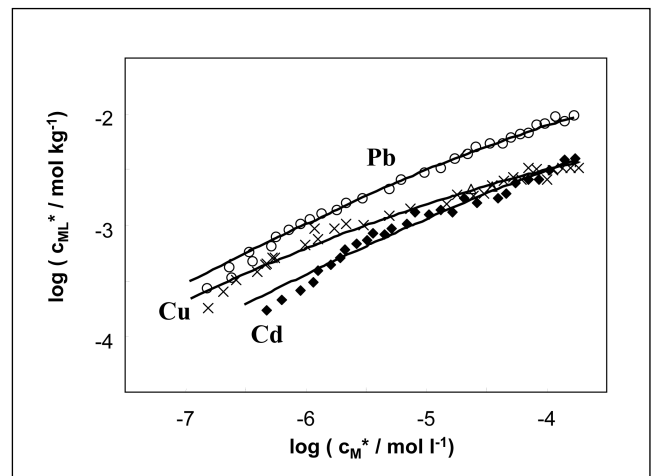

Figure 6. Experimental (symbols) and fitted (lines) binding curves obtained by RPP corresponding to the heterogeneous complexation of Cd ( $\blacklozenge$ ), Pb (O) and Cu ( $\times$ ) by fulvic acid in a  $5 \text{ mmol l}^{-1}$  succinic acid buffer at  $\text{pH} = 6.0$  in the presence of  $0.1 \text{ mol l}^{-1} \text{ KNO}_3$ .

Although some authors have pointed out that the Donnan approximation seems unrealistic when applied to relatively small molecules such as fulvic acids, it has been widely used in the literature.

Figure 5 shows a schematic representation of the method proposed and Figure 6 some of the binding curves obtained for a fulvic acid by the method proposed above.

### Soft modelling in the complexation by molecules of biological interest

Multivariate Curve Resolution with Alternating Least Squares (MCR-ALS) has been shown to be a powerful tool in solution equilibria studies by spectroscopic means [15, 16]. We have

adapted this method for metal complexation studies by voltammetry and progressively introduced some improvements in the general method, due to the special characteristics of the electrochemical data.

In the following section we describe the soft-modelling method used.

Application of Factor Analysis (FA) techniques [14] to different types of instrumental data requires carefully planned experiments. The conditions for the application of MCR-ALS to voltammetric data can be summarised as: *i)* experimental currents must be measured at equally spaced potentials that are always identical, and *ii)* the currents should be linearly dependent on the concentration of the electroactive species present in the investigated system. The last condition is not necessarily true *a priori* in an electrochemical

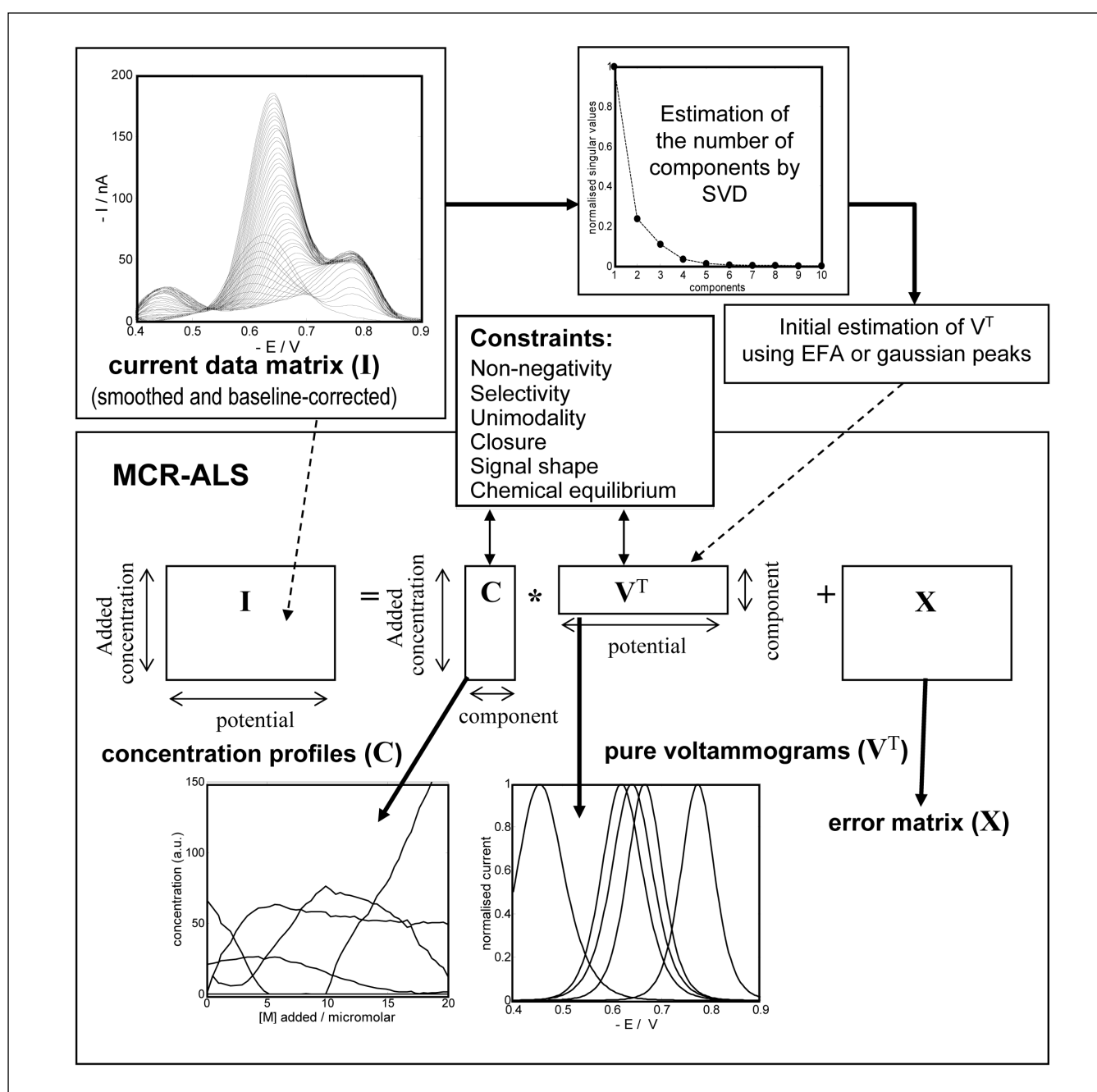

Figure 7. Flow chart for the soft-modelling MCR-ALS method applied to voltammetric studies of metal complexation.



measurement, and it represents a critical point in the application of MCR-ALS, which will be discussed further.

In order to obtain high-quality data, the voltammograms used for data treatment should ideally correspond to the average of several consecutive experimental curves obtained using different electrodes, usually mercury drop electrodes (SMDE or HMDE) because of their extremely high reproducibility. Moreover, a point-by-point subtraction of the background current (obtained for supporting electrolyte) from the total currents obtained in the presence of the studied system is performed. This charging current subtraction assumes that the electrode double-layer capacitance does not change significantly in the presence of the test compound.

Comparative studies with different voltammetric techniques [13] have shown that the best results with MCR-ALS are obtained with peak-shaped signals (as compared with sigmoidal-shaped ones) with practically equal base lines on both sides of the peaks. Of course, this is not directly possible with all techniques because of the characteristics of their signals. Then, either a previous derivation of data (for sigmoidal-shaped techniques such as NPP and RPP) or an additional baseline correction (for asymmetric-peak-shaped techniques such as Linear Sweep Voltammetry (LSV)) can be performed.

Voltammograms (previously prepared as mentioned above) must be arranged in a data matrix of currents  $I(nR, nC)$ , with as many  $nR$  rows as number of recorded voltammograms at each metal-to-ligand ratio, and as many  $nC$  columns as potentials scanned during the current measurements.

The first basic goal of the method is to decompose mathematically the experimental current data matrix  $I$  into a product of two abstract orthogonal matrices, usually denoted *scores*  $Q(nR, nS)$  and *loadings*  $P^T(nS, nC)$ , for a pre-selected number of components  $nS$ , contributing to the measured signal. This can be expressed as:

$$I = QP^T + X \quad (20)$$

where  $X$  is a residual matrix containing the variance not explained by  $Q$  and  $P^T$ .

The general procedure for voltammetric data is comprised of a series of steps summarised in Fig. 7 and described in the following. The resolution power of the method is strongly enhanced by simultaneous analysis of several data matrices obtained using different voltammetric techniques and different voltammetric titrations of the same metal-ligand system [15, 16]. As an example, data analysis can be performed using augmented column- or row-wise matrices such as those shown in Figure 8. The steps of the process are the following:

#### a) Detection of the number of components

The number of chemical contributions,  $nS$ , or pseudorank (mathematical rank in absence of noise), of the matrix  $I$  is chosen to minimize the residual data variance in  $X$  (eqn. 20),

leaving in, if possible, only the experimental error or noise contribution.

Among the many methods proposed for such a selection of the number of components, in the present work Singular Value Decomposition (SVD) [39] is used. In SVD, from the visual inspection of the plot of the magnitude of singular values of matrix  $I$  as a function of the number of components, the more probable number of components is derived. Moreover, the magnitude of residuals, expressed as a percentage of lack-of-fit (lof) or unexplained data variance in  $X$  after a particular number of principal components, is calculated:

$$lof = \sqrt{\frac{\sum_{i,j} (d_{ij} - \hat{d}_{ij})^2}{\sum_{i,j} d_{ij}^2}} \quad (21)$$

where  $d_{ij}$  are the experimental values and  $\hat{d}_{ij}$  are the corresponding calculated values using the SVD decomposition.

#### b) Initial estimations for ALS

Once the number of components is estimated by SVD, the data structure can be analysed using Evolving Factor Analysis (EFA) [40], which provides an estimation of the regions or windows of existence of each species. In the present MCR-ALS method, EFA can provide an initial estimation of how the concentration profiles of these components change along the experiment. The EFA method is based on the evaluation of the magnitude of the singular values of the submatrices (of a matrix  $I$ ) built up by successively adding one by one all the rows of the original data matrix in the forward (starting with the two first voltammograms) and the backward direc-

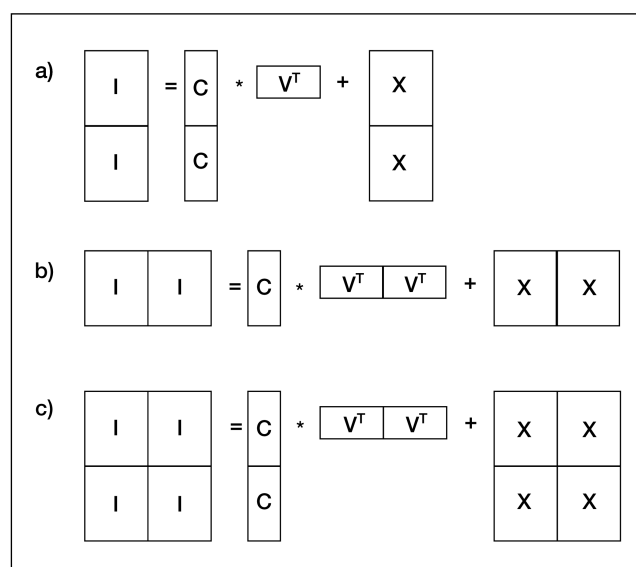

Figure 8. Possible data matrix arrangements for soft-modelling MCR-ALS analysis of linear models:  $I$  is the data matrix (currents measured at several concentrations of the ligand and several potentials),  $C$  is the component concentration matrix,  $V$  is the individual voltammograms matrix for the  $n$  components and  $X$  is the residual matrix. a) Different experiments with the same technique; b) different techniques for the same experiment; and c) different techniques for different experiments

tion (starting with the last two voltammograms). A component is detected by the increase (in the forward direction) or the disappearance (in the backward direction) of a new singular value.

In some cases, initial estimations of individual voltammograms are preferable. They can be estimated by EFA (from the transpose of matrix  $I$ ), experimentally acquired at metal-to-ligand ratios where one component clearly predominates, or simulated from basic theoretical equations, valid for a certain technique and physico-chemical model, or from standard parametric functions that can reasonably fit the experimental signals.

Thus, for instance, simulated voltammetric signals (matrix  $V$ ) of Differential Pulse Polarography DPP can be used. The DPP current  $\delta_i$  for a potential  $E$  is the difference between the currents measured after and before the application of a potential pulse over-imposed to this potential  $E$ . The dependence of  $\delta_i$  with  $E$  (DP polarogram) is given by the expression [41]:

$$\delta_i = \frac{nFAD^{1/2}c}{\pi^{1/2}t_p^{1/2}} \left[ \frac{P_A(1-\sigma^2)}{(\sigma+P_A)(1+P_A\sigma)} \right] \quad (22)$$

where:

$$P_A = \exp \left[ \frac{nF}{RT} \left( E + \frac{\Delta E}{2} - E_{1/2} \right) \right] \quad (23)$$

$$\sigma = \exp \left( \frac{nF}{RT} \frac{\Delta E}{2} \right) \quad (24)$$

and where  $n$  is the number of electrons transferred in the electrochemical process,  $F$  is the Faraday,  $A$  is the electrode surface,  $\Delta E$  is the pulse amplitude and  $t_p$  is the pulse duration.

An alternative procedure to obtain initial estimations of the individual voltammograms and to ensure the peak-shape during the iteration procedure is by means of some mathematical equations producing peak-shaped signals. Thus, we have widely used the following parametric asymmetric logistic function:

$$v = a \left[ 1 + \exp \left( - \frac{E + c \ln(d) - b}{c} \right) \right]^{-d-1} d^{-d} (d+1)^{d+1} \exp \left( - \frac{E + c \ln(d) - b}{c} \right) \quad (25)$$

where  $v$  is the pure current,  $E$  is the potential and  $a$ ,  $b$ ,  $c$ ,  $d$  are adjustable parameters. For initial estimations, simpler gaussian peaks can also be applied:

$$v = a \exp \left[ - \frac{(E-b)^2}{c} \right] \quad (26)$$

where  $a$ ,  $b$ , and  $c$  are again adjustable parameters that determine the height, position and width of the peak, respectively.

### c) Alternating Least Squares optimisation

From initial estimations of concentration profiles or individual

voltammograms, a constrained Alternating Least Squares (ALS) optimisation is initiated to try to recover the correct set of concentration profiles and pure individual voltammetric responses. This recovery is based on the assumption that the instrumental responses of the chemical contributions are bilinear and can be expressed in the matrix equation:

$$I = CV + X \quad (27)$$

where  $C$  is a matrix with a number of rows equal to the number of experimentally measured voltammograms and a number of columns equal to the number of proposed chemical contributions, describing how their concentrations change. On the

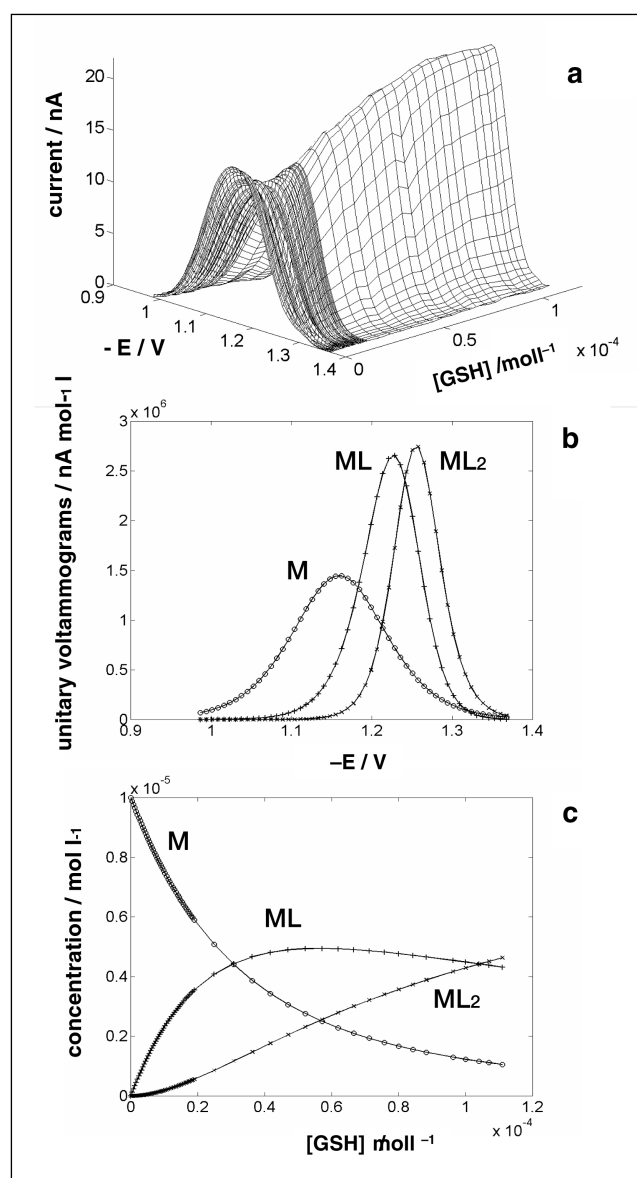

Figure 9. Experimental current data matrix (a) obtained in the titration of a solution containing  $1 \times 10^{-5} \text{ mol L}^{-1}$  of Zn(II) and  $0.15 \text{ mol L}^{-1}$  of borate buffer with glutathione (GSH) at pH 8.5. The application of MCR-ALS by assuming 3 components and applying the constraints of non-negativity, closure, signal shape and chemical equilibrium produces a matrix of pure voltammograms (b) and a matrix of concentration profiles (c) with a lack of fit of 5.95%. The components can be attributed to the successive complexes M, ML (or  $M_2L_2$ ) and  $ML_2$ , whose respective conditional stability constants are estimated by MCR-ALS to be  $\log \beta'_1 = 4.6$  and  $\log \beta'_2 = 6.8$ .

other hand,  $V$  is a matrix with a number of rows equal to the number of proposed chemical contributions and with number of columns equal to the number of scanned potentials, describing how then pure individual voltammograms (i.e., the current per unit of concentration at each potential) are.

When an initial estimation of the individual voltammograms is initially available, the best least squares solution of the concentration profiles is estimated from

$$C=IV^+ \quad (28)$$

where  $V^+$  is the pseudo-inverse [39] of  $V$  matrix. If, on the contrary, an initial estimation of the concentration profiles is available, the best least squares estimation of the voltammetric contributions is estimated from:

$$V=C^+I \quad (29)$$

where  $C^+$  is now the pseudo-inverse of  $C$  matrix.

The least squares solutions obtained in this way are pure mathematical solutions. However, they probably will not be optimal from a chemical point of view. Therefore an ALS op-

timisation procedure is initiated, resolving by iteration the two equations previously given and constraining, at each stage of the iterative optimisation, the solutions to fulfil some conditions. The constraints usually applied in spectroscopic studies are:

- i) non-negativity of concentrations,
- ii) non-negativity of the signals,
- iii) unimodality of the concentrations,
- iv) unimodality of the signals,
- v) selectivity (presence in parts of the experiment of only some of the species), and
- vi) closure (the sum of the concentrations of the metal ion or the ligand, depending on the experimental design, remains constant).

Due to the characteristics of electrochemical data, during our systematic application of MCR-ALS to voltammetric data we have implemented two additional constraints:

- vii) peak-shape constraint (takes into account the

Table 2. Summary of the different metal complex systems studied by the combined use of voltammetric techniques and Multivariate Curve Resolution by Alternating Least Squares optimisation (MCR-ALS)

<i>Systems</i>	<i>Techniques</i>	<i>Comments</i>	<i>References</i>
Zn-PAA, Zn-PMA	NPP, RPP, DPP, DPASV	Macromolecular 1:1 labile complexes	43
Cd-GSH	DPP	Speciation; Signal-shape constraint	44, 45
	CV	Improvement of method to cyclic techniques	52
Cd-propanoate	NPP, RPP, DPP, DPASV	Successive and labile weak complexes	46
Cd-NTA	DCP, DPP, DPASV	Inert and strong 1:1 complex	47
Zn-GSH	NPP, RPP, DPP	Speciation	48, 53
	DPP	Implementation of a chemical equilibrium constraint	56
Zn-FT	DPP, EXAFS	Speciation	49, 65
Cd-FT	DPP, LSV, $^{113}\text{Cd}$ -NMR, CD, EXAFS	Comparison voltammetry/MCR-ALS vs. spectroscopy	50, 51, 65
Cu –Tannic Acid	DPP	Presence of intermediate Cu(I) complexes	54
Cd-Zn-FT	SWV, DPP	Metal mixed system (exchange experiments)	55, 61, 64
Cd-1,10-phenanthroline	NPP, RPP, DPP	Implementation of a chemical equilibrium constraint	56
Cd-glycine, Pb-glycine	NPP, RPP, DPP	Successive and labile weak complexes	57
Pb-GSH	DPP	Interference of anodic signals of Hg electrode	58
Zn-glycine	DCP, DPP	Both electrochemically labile and inert complexes	59
Cd-Cys-Gly	DPP	MCR-ALS analysis of augmented matrices	60
Cd- $\gamma$ -Glu-Cys	DPP	MCR-ALS analysis of augmented matrices	60
Cd-PC <sub>2</sub>	DPV	MCR-ALS analysis of phytochelatins	62
Cd – Humic Acid	DPASV	Detection of two types of complexation	63
Cd-(Zn-MT)	SWV, DPP	Metal exchange properties of a natural MT	64

*Compounds:*

PAA, polyacrylic acid; PMA, polymethacrylic acid; GSH, glutathione; NTA, nitrilotriacetic acid; FT, (56-61) C-terminal fragment of the mammalian metallothionein: Lys-Cys-Thr-Cys-Cys-Ala; PC<sub>2</sub>, phytochelatin ( $\gamma$ -Glu-Cys)<sub>2</sub>Gly; (Zn-MT), Zn-containing mammalian metallothionein.

*Techniques:*

NPP, Normal Pulse Polarography; RPP, Reverse Pulse Polarography; DPP, Differential Pulse Polarography; DPASV, Differential Pulse Anodic Stripping Voltammetry; CV, Cyclic Voltammetry; DCP, Direct Current Polarography; EXAFS, Extended X-ray Absorption Fine Structure Spectroscopy; LSV, Linear Sweep Voltammetry;  $^{113}\text{Cd}$ -NMR,  $^{113}\text{Cd}$  Nuclear Magnetic Resonance; CD, Circular Dichroism; SWV, Square Wave Voltammetry.

expected peak-shaped signal of the technique used through a proper parametric equation), and  
viii) chemical equilibrium constraint for systems with successive metal complexes.

In all cases the relative error of the matrix decomposition is expressed as a percentage of lack of fit (lof), according to the function:

$$\text{lof} = \sqrt{\frac{\sum_{i,j} (I_{ij} - \hat{I}_{ij})^2}{\sum_{i,j} \hat{I}_{ij}^2}} \quad (30)$$

where  $I_{ij}$  are the elements of the experimental matrix  $I$ , and  $\hat{I}_{ij}$  the corresponding calculated elements of the  $I$  matrix as the product of  $C$  and  $V$  estimated by ALS.

All the programs included in the MCR-ALS method have been implemented using Matlab high-performance numeric computation and visualisation software [42].

Figure 9 summarizes the performance of MCR-ALS applied to voltammetric data of metal-ligand equilibria. From a set of experimental data (obtained in the titration of a metal with a ligand or vice versa) collected in a current data matrix (plotted as Figure 9a), the unitary voltammogram of every electrode process (Figure 9b) and the relative importance of every process (Figure 9c, designated concentration profiles) are reached. From the location (in the potential axis) of the unitary voltammograms we can deduce the relative electrochemical stability of each compound, and from the concentration profiles we can reach stoichiometric information. Thus, we can formulate both a global electrode process and a complexation model.

Table 2 summarizes some of the metal complex systems investigated with the MCR-ALS approach.

## Conclusions

Voltammetry is an excellent tool for the study of metal solution equilibria and for metal speciation. However, due to the great variety of metal complex systems and of the characteristics of the recorded voltammetric signals, the availability of different approaches is of the highest interest. Thus, besides the more classical and mathematically rigorous hard-modelling approaches, the soft-modelling ones, and in particular MCR-ALS, have proved to be extremely useful.

## Acknowledgements

The authors thank many coworkers and colleagues that have contributed to the research summarized here: R. Tauler, F. Berbel, M.S. Díaz-Cruz, B.H. Cruz, A. Monjonell, R. Serra, M.J. López, M. Torres, J. Agulló, C. de Haro, J. Cortés, F. Mas and J.L. Garcés; J. Puy, J. Galceran, J. Sal-

vador, J. Cecília and D. Reñé (University of Lleida); H.P. van Leeuwen (University of Wageningen, NL, and temporally Iberdrola Visiting Professor of Science and Technology in the University of Barcelona); B.S. Grabaric and Z. Grabaric (University of Zagreb, Croatia, and temporally Visiting Professors in the University of Barcelona); J. Mendieta (University of Alcalá de Henares, and temporally researcher in the University of Barcelona); A.R. Rodríguez and C. Harlyk (IRMM-JRC EU, Geel, Belgium); M. Fernández (Universidad de La Habana, Cuba, and grant holder in the University of Barcelona); I. Sestakova (J. Heyrovsky Institute of the Academy of Science of the Czech Republic, Prague); J. Velek (Institute of Organic Chemistry and Biochemistry of the Academy of Science of the Czech Republic, Prague); M. Maeder (University of Newcastle, Australia, and temporally Iberdrola Visiting Professor of Science and Technology in the University of Barcelona); M.C. Antunes (University of Trás-os-Montes e Alto Douro, Portugal). Last, but not least, the authors thank the invaluable mastery and support of Prof. Enric Casassas (1920 – 2000).

The authors gratefully acknowledge financial support from the Spanish *Ministerio de Ciencia y Tecnología* (Projects PB96-0379-CO3 and BQU2000-0642-CO3-01), *Generalitat of Catalonia* (Projects 1997SGR-00385 and 1999SGR-00048), and Iberdrola S.A. for a Visiting Professorship Program.

## References

- [1] A. Tessier and D.R. Turner Eds., Metal speciation and bioavailability in aquatic systems, Wiley, New York, 1995.
- [2] J.J. Lingane, Interpretation of the polarographic waves of complex metal ions, *Chem. Rev.* 29 (1941) 1.
- [3] D.D. DeFord, D.N. Hume, The determination of consecutive formation constants of complex ions from polarographic data, *J. Am. Chem. Soc.* 73 (1951) 5321.
- [4] W.B. Schaap, D.L. McMasters, Polarographic study of mixed-ligand complex formation; complexes of copper and cadmium with oxalate ion and ethylenediamine, *J. Am. Chem. Soc.* 83 (1961) 4699.
- [5] I. Cukrowski, A polarographic method of speciation for labile metal-ligand systems based on mass-balance equations. A differential pulse polarographic study at fixed ligand to metal ratio and varied pH, *Anal. Chim. Acta* 336 (1996) 23.
- [6] E. Casassas, L. Eek, Polarographic determination of stability constants of some metal complexes by measurement of the ligand cathodic wave displacement, *J. Chim. Phys.* 64 (1967) 971.
- [7] V. Kacena, L. Matousek, Proteins and aminoacids. XVI. II. The effect of electrolytes on proteins, *Coll. Czech. Chem. Commun.* 18 (1953) 294.
- [8] H.G. de Jong, H.P. van Leeuwen, K. Holub, Voltammetry of metal complex systems with different diffusion coefficients of the species involved. Part I. Analytical

- approaches to the limiting current for the general case including association/dissociation kinetics, *J. Electroanal. Chem.* 234 (1987) 1.
- [9] H.G. de Jong, H.P. van Leeuwen, Voltammetry of metal complex systems with different diffusion coefficients of the species involved. Part II. Behavior of the limiting current and its dependence on association/dissociation kinetics and lability, *J. Electroanal. Chem.* 234 (1987) 17.
- [10] H.G. de Jong, H.P. van Leeuwen, Voltammetry of metal complex systems with different diffusion coefficients of the species involved. Part III. The current-potential relation for the general case including association/dissociation kinetics, *J. Electroanal. Chem.* 235 (1987) 1.
- [11] M. Esteban, C. Ariño, J.M. Díaz-Cruz, E. Casassas, Voltammetry of Metal-ion / Macromolecule Interactions: Application to speciation problems, *Trends Anal. Chem.* 12 (1993) 276.
- [12] S.D. Brown, R.S. Bear Jr., Chemometric techniques in electrochemistry: A critical review, *Crit. Rev. Anal. Chem.* 24 (1993) 99.
- [13] M. Esteban, C. Ariño, J.M. Díaz-Cruz, M.S. Díaz-Cruz, R. Tauler, Multivariate curve resolution with alternating least squares optimisation: a soft-modelling approach to metal complexation studies by voltammetric techniques, *Trends Anal. Chem.* 19 (2000) 49.
- [14] E.R. Malinowski, *Factor Analysis in Chemistry*, Wiley, New York, 1991.
- [15] R. Tauler, A. Izquierdo-Ridorsa, E. Casassas, Simultaneous analysis of several spectroscopic titrations with self-modelling curve resolution, *Chemometr. Intell. Lab. Syst.* 18 (1993) 293.
- [16] R. Tauler, A.K. Smilde, B.R. Kowalski, Selectivity, local rank, three way data analysis and ambiguity in multivariate curve resolution, *J. Chemometr.* 9 (1995) 31.
- [17] F. Berbel, J.M. Díaz-Cruz, C. Ariño, M. Esteban, Voltammetry of metal ions in mixtures of ligands. Part I. Theoretical formulation and application to 1:1 labile complexes, *J. Electroanal. Chem.* 431 (1997) 99.
- [18] F. Berbel, J.M. Díaz-Cruz, C. Ariño, M. Esteban, Voltammetry of metal ions in mixtures of ligands. Part II. Application to successive labile complexes, *J. Electroanal. Chem.* 432 (1997) 243.
- [19] F. Berbel, J. Cortés, J.M. Díaz-Cruz, C. Ariño, M. Esteban, Anodic Stripping Voltammetry of metal ions in mixtures of ligands, *Electroanalysis* 10 (1998) 417.
- [20] F. Berbel, J.M. Díaz-Cruz, C. Ariño, M. Esteban, Voltammetry of metal ions in mixtures of ligands. Part III. Application to systems including inert complexes, *J. Electroanal. Chem.* 453 (1998) 151.
- [21] C. De Haro, F. Berbel, J.M. Díaz-Cruz, C. Ariño, M. Esteban, Voltammetric metal speciation in mixtures of inert and labile macromolecular complexes at any ligand-to-metal ratio: differential pulse polarographic study of the Zn(II) – nitrilotriacetate – polymethacrylate system, *J. Electroanal. Chem.* 462 (1999) 157.
- [22] F. Berbel, J.M. Díaz-Cruz, C. Ariño, M. Esteban, Voltammetry of sparingly soluble metal complexes: a differential pulse polarographic study of the Zn(II) – oxalate system, *J. Electroanal. Chem.* 475 (1999) 99.
- [23] J. Puy, F. Mas, J.M. Díaz-Cruz, M. Esteban, E. Casassas, Induced Reactant Adsorption in Metal-Polyelectrolyte Systems: Pulse Polarographic Study, *Anal. Chim. Acta* 268 (1992) 261.
- [24] F. Mas, J. Puy, J.M. Díaz-Cruz, M. Esteban, E. Casassas, Induced Reactant Adsorption in Normal Pulse Polarography of Labile Metal – Polyelectrolyte Systems. Part I.– Study of Current-Potential Relationship assuming Potential-independent adsorption parameters, *J. Electroanal. Chem.* 326 (1992) 299.
- [25] J. Puy, F. Mas, J. M. Díaz-Cruz, M. Esteban, E. Casassas, Induced Reactant Adsorption in Normal Pulse Polarography of Labile Metal – Polyelectrolyte Systems. Part II.– Study of Current-Potential Relationship assuming Potential-Dependent Adsorption parameters, *J. Electroanal. Chem.* 328 (1992) 271.
- [26] F. Mas, J. Puy, J.M. Díaz-Cruz, M. Esteban, E. Casassas, A semiempirical full-wave expression for Induced Reactant Adsorption in Normal Pulse Polarography of labile Metal – Polyelectrolyte Systems, *Anal. Chim. Acta* 273 (1993) 297.
- [27] J. Puy, J. Salvador, J. Galceran, M. Esteban, J.M. Díaz-Cruz, F. Mas, Voltammetry of Labile Metal Complex Systems with Induced Reactant Adsorption: Theoretical analysis for any ligand-to-metal ratio, *J. Electroanal. Chem.* 360 (1993) 1.
- [28] J. Puy, J. Galceran, J. Salvador, J. Cecilia, J.M. Díaz-Cruz, M. Esteban, F. Mas, Voltammetry of labile metal-macromolecular systems for any ligand-to-metal ratio including adsorption phenomena. The role of the stability constant, *J. Electroanal. Chem.* 374 (1994) 223.
- [29] J. Galceran, D. Reñé, J. Salvador, J. Puy, M. Esteban, F. Mas, Reverse pulse polarography of labile metal + macromolecule systems with induced reactant adsorption: theoretical analysis and determination of complexation and adsorption parameters, *J. Electroanal. Chem.* 375 (1994) 307.
- [30] J. Galceran, J. Salvador, J. Puy, J. Cecilia, M. Esteban, F. Mas, Influence of adsorption on calibration curves in normal pulse polarography, *Anal. Chim. Acta* 305 (1995) 273.
- [31] J. Galceran, J. Salvador, J. Puy, F. Mas, D. Giménez, M. Esteban, Amalgamation effects in Reverse Pulse Polarography at spherical electrodes. Influence on speciation measurements, *J. Electroanal. Chem.* 442 (1998) 151.
- [32] J. Puy, M. Torrent, J. Monné, J. Cecilia, J. Galceran, J. Salvador, F. Mas, F. Berbel, Influence of the adsorption phenomena on the NPP and RPP limiting currents for labile metal-macromolecules systems, *J. Electroanal. Chem.* 457 (1998) 229.
- [33] R. Serra, F. Mas, J.M. Díaz-Cruz, C. Ariño, M. Esteban, Heterogeneity of Cd(II)-macromolecule systems: A potentiometric study, *Electroanalysis* 12 (2000) 60.

- [34] F. Berbel, J.M. Díaz-Cruz, C. Ariño, M. Esteban, F. Mas, J.L. Garcés, J. Puy, Voltammetric analysis of heterogeneity in metal ion binding by humics, *Environ. Sci. Technol.* 35 (2001) 1097.
- [35] D.G. Kinniburgh, C.J. Milne, M.F. Benedetti, J.P. Pinheiro, J. Filius, L.K. Koopal, W.H. Riemsdijk, Metal binding by humic acid: Application of the NICA-Donnan model, *Environ. Sci. Technol.* 30 (1996) 1687.
- [36] M.F. Benedetti, W.H. Riemsdijk, L.K. Koopal, Humic substances considered as a heterogeneous Donnan gel phase, *Environ. Sci. Technol.* 30 (1996) 1805.
- [37] D.G. Kinniburgh, W.H. Riemsdijk, L.K. Koopal, L.K. Borkovec, M.F. Benedetti, M. J. Avena, Ion binding to natural organic matter: competition, heterogeneity, stoichiometry and thermodynamic consistency, *Colloids Surf. A* 151 (1999) 147.
- [38] W.H. Riemsdijk, L.K. Koopal, Ion binding by natural heterogeneous particles, in *Environmental Particles*, J. Buffle, H.P. van Leeuwen Eds., Vol. 1, Lewis Publishers, Michigan, 1992.
- [39] G.H. Golub, Ch.F. van Loan, *Matrix Computation*, Johns Hopkins University Press, Baltimore, 1989.
- [40] H. Gampp, M. Maeder, Ch. Meyer, A.D. Zuberbühler, Calculation of equilibrium constants from multiwavelength spectroscopic data. III. Model-free analysis of spectrophotometric and ESR titrations, *Talanta* 32 (1985) 1133.
- [41] A.J. Bard, L.R. Faulkner, *Electrochemical Methods. Fundamentals and Applications*, 2<sup>nd</sup> edition, Wiley, New York, 2000.
- [42] Matlab version 4.2. MathWorks Inc., Cochituate Place, 1994.
- [43] J.M. Díaz-Cruz, R. Tauler, B.S. Grabaric, M. Esteban, E. Casassas, Application of multivariate curve resolution to the voltammetric data. Part 1. Study of Zn(II) complexation with some polyelectrolytes, *J. Electroanal. Chem.* 393 (1995) 7.
- [44] J. Mendieta, M.S. Díaz-Cruz, R. Tauler, M. Esteban, Application of multivariate curve resolution to the voltammetric data. Part 2. Study of metal-binding properties of the peptides, *Anal. Biochem.* 240 (1996) 134.
- [45] M.S. Díaz-Cruz, J. Mendieta, R. Tauler, M. Esteban, Cadmium binding properties of glutathione: a chemometrical analysis of voltammetric data, *J. Inorg. Biochem.* 66 (1997) 29.
- [46] B.S. Grabaric, Z. Grabaric, R. Tauler, M. Esteban, E. Casassas, Application of multivariate curve resolution to the voltammetric data. Factor Analysis ambiguities in the study of weak consecutive complexation of metal ion with ligand, *Anal. Chim. Acta* 341 (1997) 105.
- [47] M. Torres, J.M. Díaz-Cruz, C. Ariño, B.S. Grabaric, R. Tauler, M. Esteban, Multivariate curve resolution analysis of voltammetric data obtained at different time windows: study of the system Cd(II) – nitrilotriacetic acid, *Anal. Chim. Acta* 371 (1998) 23.
- [48] M.S. Díaz-Cruz, J. Mendieta, A. Monjonell, R. Tauler, M. Esteban, Study of the zinc binding properties of glutathione by differential pulse polarography and multivariate curve resolution, *J. Inorg. Biochem.* 70 (1998) 91.
- [49] M.S. Díaz-Cruz, J. Mendieta, A. Monjonell, R. Tauler, M. Esteban, Zinc binding properties of the C-terminal hexapeptide Lys-Cys-Thr-Cys-Cys-Ala from mouse metallothionein: analysis by differential pulse polarography and multivariate curve resolution, *Anal. Chim. Acta* 385 (1999) 353.
- [50] J. Mendieta, M.S. Díaz-Cruz, A. Monjonell, R. Tauler, M. Esteban, Cadmium-binding properties of the C-terminal hexapeptide Lys-Cys-Thr-Cys-Cys-Ala from mouse metallothionein: study by differential pulse polarography and circular dichroism spectroscopy with multivariate curve resolution analysis, *Anal. Chim. Acta* 390 (1999) 15.
- [51] M. Esteban, C. Harlyk, A.R. Rodríguez, Cadmium-binding properties of the C-terminal hexapeptide from mouse metallothionein: study by linear sweep voltammetry and multivariate curve resolution analysis, *J. Electroanal. Chem.* 468 (1999) 202.
- [52] M.S. Díaz-Cruz, J. Mendieta, R. Tauler, M. Esteban, Multivariate curve resolution of cyclic voltammetric data: Application to the study of the cadmium binding properties of glutathione, *Anal. Chem.* 71 (1999) 4629.
- [53] M.S. Díaz-Cruz, J.M. Díaz-Cruz, J. Mendieta, R. Tauler, M. Esteban, Soft- and hard-modeling approaches for the determination of stability constants of metal-peptide systems by voltammetry, *Anal. Biochem.* 279 (2000) 189.
- [54] B.H. Cruz, J.M. Díaz-Cruz, C. Ariño, R. Tauler, M. Esteban, Multivariate Curve Resolution of polarographic data applied to the study of the copper-binding ability of tannic acid, *Anal. Chim. Acta* 424 (2000) 203.
- [55] M.S. Díaz-Cruz, M. Esteban, A.R. Rodríguez, Square wave voltammetry data analysis by Multivariate Curve Resolution: Application to the mixed-metal system Cd-Zn-{Lys-Cys-Thr-Cys-Cys-Ala}, *Anal. Chim. Acta* 428 (2001) 285.
- [56] J.M. Díaz-Cruz, J. Agulló, M.S. Díaz-Cruz C. Ariño, M. Esteban, R. Tauler, Implementation of a chemical equilibrium constraint in the multivariate curve resolution of voltammograms from systems with successive metal complexes, *Analyst* 126 (2001) 371.
- [57] M. Fernández, C. Ariño, J.M. Díaz-Cruz, R. Tauler, M. Esteban, Soft modelling approach applied to voltammetric data: study of electrochemically labile metal-glycine complexes, *J. Electroanal. Chem.* 505 (2001) 44.
- [58] B.H. Cruz, J.M. Díaz-Cruz, M.S. Díaz-Cruz, C. Ariño, M. Esteban, R. Tauler, Differential pulse polarographic study of the Pb(II) complexation by glutathione, *J. Electroanal. Chem.* 516 (2001) 110.
- [59] M. Fernández, C. Ariño, J.M. Díaz-Cruz, R. Tauler, M. Esteban, Voltammetric soft modelling approach for systems with both electrochemically labile and inert complexes: the Zn-glycine case, *Electroanalysis* 13 (2001) 1405.

- [60] B.H. Cruz, J.M. Díaz-Cruz, C. Ariño, M. Esteban, R. Tauler, Study of the Cd<sup>2+</sup> complexation by the glutathione fragments Cys-Gly (CG) and  $\gamma$ -Glu-Cys ( $\gamma$ -EC) by differential pulse polarography, *Analyst* 127 (2002) 401.
- [61] M.S. Díaz-Cruz, J. Mendieta, M. Esteban, Combined use of Differential Pulse Polarography and Multivariate Curve Resolution: As applied to the study of metal mixed complexes of the metallothionein related hexapeptide Lys-Cys-Thr-Cys-Cys-Ala, *Electroanalysis* 14 (2002) 50.
- [62] B.H. Cruz, J.M. Díaz-Cruz, I. Sestakova, J. Velek, C. Ariño, M. Esteban, Differential pulse voltammetric study of the complexation of Cd(II) by the phytochelatin ( $\gamma$ -Glu-Cys)<sub>2</sub>Gly assisted by multivariate curve resolution, *J. Electroanal. Chem.* 520 (2002) 111.
- [63] M.C. Antunes, J.E. Simao, A.C. Duarte, M. Esteban, R. Tauler, Application of multivariate curve resolution to the voltammetric study of the complexation of fulvic acids with cadmium (II) ions, *Anal. Chim. Acta* 459 (2002) 291.
- [64] M.S. Díaz-Cruz, M.J. López, J.M. Díaz-Cruz, M. Esteban, Comparison of the zinc-cadmium exchange properties of the metallothionein related hexapeptide Lys-Cys-Thr-Cys-Cys-Ala and a zinc-containing metallothionein: study by voltammetry and Multivariate Curve Resolution, *J. Electroanal. Chem.* 523 (2002) 114.
- [65] M.S. Díaz-Cruz, J.M. Díaz-Cruz, M. Esteban, Comparison of voltammetry assisted by Multivariate Analysis with EXAFS as applied to the study of Cd- and Zn-binding of metallothionein related peptides, *Electroanalysis* 14 (2002) 899.

## About the authors

The authors are staff members of the research group on Electroanalytical Chemistry of the Department of Analytical Chemistry of University of Barcelona. The group is specialised in the development of both theoretical and experimental electroanalytical approaches for metal complexation and metal speciation in complex media, especially those containing macromolecular compounds of environmental and/or biological interest. The group has performed pioneering work on the application of chemometrical techniques to electroanalytical data from systems involving metal complexation equilibria, and on the development of an expert system for metal determination by voltammetric means. The group also has extensive experience in the development of electroanalytical methods for a variety of analytes. Recently, the application of chemometrical tools and ultramicroelectrode-based devices to voltammetric measurements in flow systems have become new subjects of interest.

Prof. Miquel Esteban received his Ph.D. in Chemistry from the University of Barcelona in 1984, where he has

been Professor of Analytical Chemistry since 1993. He has spent research periods in the *Institut für Angewandte Physikalische Chemie* in the *Kernforschungsanlage* at Jülich, Germany, in 1986; in the Department of Physical and Colloid Chemistry of the University of Wageningen, The Netherlands, in 1987; and, as scientific visitor, at the Analytical Science Unit in the Institute for Reference Materials and Measurements (IRMM), Joint Research Centre of the European Commission, at Geel, Belgium, in 1994 and 1997. More recently, in 1999, he spent some short periods at the European Synchrotron Radiation Facilities (ESRF), in Grenoble, France, performing EXAFS studies on metallothionein- and phytochelatin-related peptides. He has directed three Ph.D. theses and has published more than 120 research articles.

Dr. Cristina Ariño received her Ph.D. in Chemistry from the University of Barcelona in 1986, where she has been Associate Professor of Analytical Chemistry since 1987. She has spent short periods in the *Laboratoire de Radiocarbonate du Centre de Datations et d'Analyses Isotopiques* (Département des Sciences de la Terre, CNRS n° 11 University Claude Bernard of Lyon,

France). She has directed a Ph.D. thesis and has published more than 50 research articles on the topics of determination of stability constants by electroanalytical techniques, heavy metal speciation, also by electroanalytical techniques, and application of chemometrics in electroanalysis. She collaborates with the *Centro Nacional de Microelectrónica (CNM)* from CSIC in Bellaterra (Spain) studying the possibilities of ultramicroelectrode-based devices in electrochemical detection.

Dr. José Manuel Díaz received his Ph.D. in Chemistry from the University of Barcelona in 1992, where he has been Associate Professor of Analytical Chemistry since 1995. He has spent research periods at the Department of Physical and Colloid Chemistry of the University of Wageningen, The Netherlands, in 1990-91 and 1993, as well as some short stays at the European Synchrotron Radiation Facilities (ESRF), in Grenoble, France. He has directed two Ph. D. theses and has published more than 50 research articles on the topics of heavy metal speciation by electroanalytical techniques and application of Chemometrics to Electroanalysis.

