

# Micro- and nano-electromechanical systems for [bio]molecular analysis

J. Bausells\*

Institut de Microelectrònica de Barcelona (Centre Nacional de Microelectrònica), Consell Superior d'Investigacions Científiques

## Resum

Les estructures micro- i nanomecàniques fabricades amb tecnologia micromecànica de silici es poden fer servir com a elements transductors en sensors [bio]químics. Bigues voladisses amb llargades d'unes desenes de micròmetres i amplades i gruixos d'un micròmetre o menys es corben per forces intermoleculars. La deformació de la biga es pot detectar per mètodes òptics o elèctrics i es pot convertir en una sortida elèctrica. En aquest treball exposem la sensibilitat i resolució d'aquests detectors moleculars electromecànics, i presentem diversos exemples de desenvolupaments que s'han fet fins ara i la seva aplicació a l'anàlisi [bio]molecular.

Paraules clau: MEMS, NEMS, microbiga voladissa, sensor bioquímic.

## Abstract

Micro- and nano-mechanical structures fabricated by silicon micromachining technology can be used as transducing elements in [bio]chemical sensors. Cantilever beams with lengths in the tens of micrometers range and widths and thicknesses in the micrometer or submicrometer range are bent by forces in the range of intermolecular forces. The cantilever deflection can be detected by optical or electrical methods and converted to an electrical output. In this work we discuss the sensitivity and resolution of such electromechanical molecular detectors, and present various examples of existing developments and their application to [bio]molecular analysis.

Keywords: MEMS, NEMS, microcantilever, biochemical sensor.

## 1. Introduction

[Bio]chemical sensors, defined as devices which convert a chemical state into an electrical signal [1], have been the subject of a strong development during the past few decades. A sensor has essentially two parts (Fig. 1): a detecting element, in which the presence of an external stimulus produces a change of some property (optical, mechanical, electrical ...), and a transducing element, which transforms this change into an electrical output signal. The sensor figures of merit, such as sensitivity, selectivity, linearity and drift, result from the combined performances of both the detecting and the transducing element. For chemical and biological sensors, a high selectivity of the detecting element to targeted analytes can be obtained using molecular or biomolecular recognition. Typically, chemical sensors have operated based on electrochemical or optical properties [2]. However, during the last few years there has been a strong increase in the use of mechanical transducers in chemical and biochemical sen-

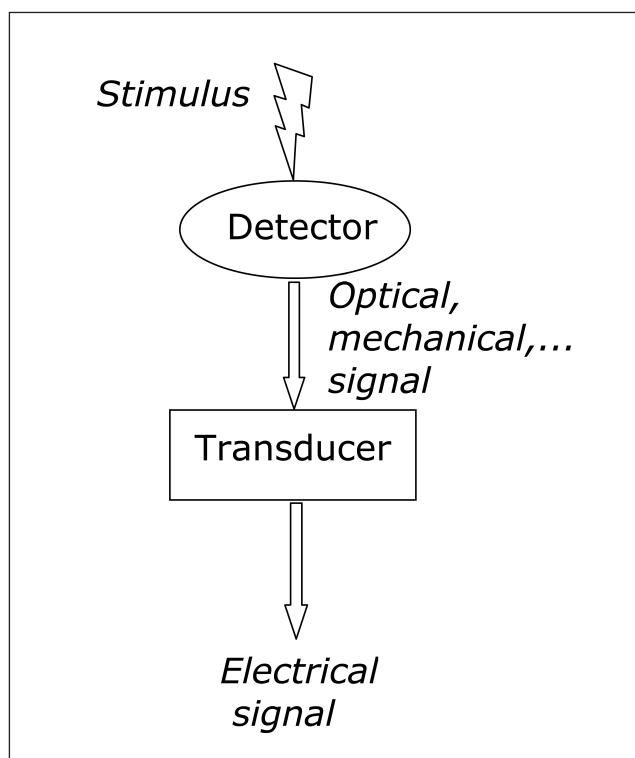

Figure 1. Structure of a sensor system.

\*Author for correspondence: Joan Bausells, Institut de Microelectrònica de Barcelona (IMB), Centre Nacional de Microelectrònica – CSIC, Campus UAB, 08193 Bellaterra, Catalonia, EU. Tel. : 34 935947700. Fax: 34 935801496. Email: Joan.Bausells@cnm.es

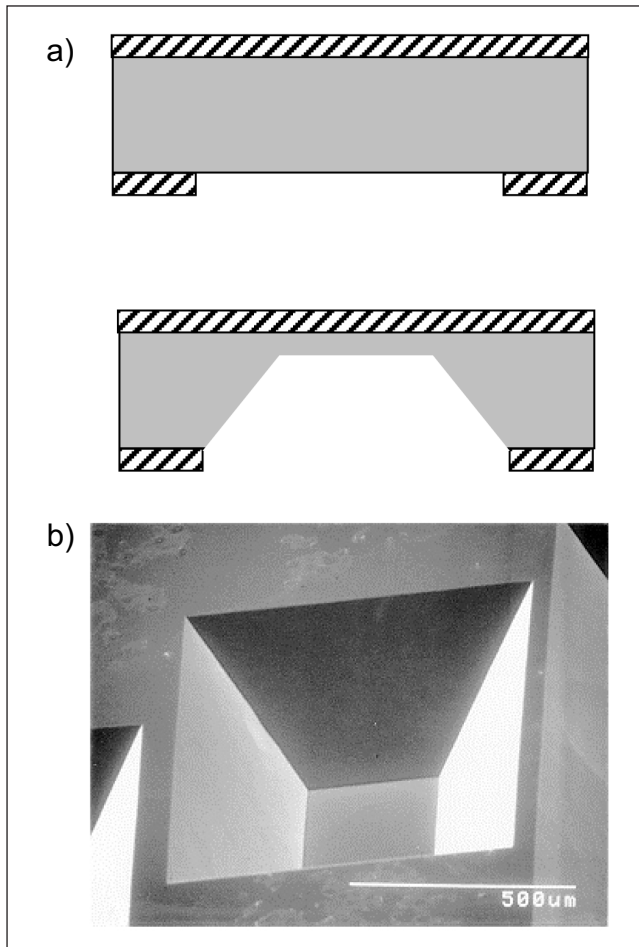

Figure 2. Silicon bulk micromachining. a) Cross section of the wet etching of a silicon membrane. Top: substrate with a back opening. Bottom: resulting membrane after etching. b) SEM micrograph of a silicon membrane from the etching side.

sors, as a result of the availability of microelectromechanical transducers.

The technology of silicon micromechanics evolved from the microelectronics technology during the 1980s [3]. As a result of

the requirement to produce defect-free high purity silicon for the manufacturing of integrated circuits, a high quality crystalline material was available. Silicon has very good mechanical properties [3]. Its yield strength (7 GPa) is about twice that of steel, with a density ( $2300 \text{ kg/m}^3$ ) that is about one third. In its crystalline form is completely elastic until the breaking point is reached, with no plastic deformation. Very precise micromechanical structures can be defined from the bulk material using wet etching or plasma etching (bulk micromachining [4], Figure 2), or by structuring thin films combined with sacrificial layers (surface micromachining [5], Figure 3). Micromechanical structures based on simple elements were used from the very beginning to obtain sensors for the measurement of mechanical quantities [3]. Typical examples are pressure sensors based on thin membranes [6] and accelerometers based on spring-mass structures, such as cantilever beams or doubly supported bridges [7].

The invention of the atomic force microscope (AFM) in 1986 [8] introduced the need for small cantilever structures to be used as AFM probes, which were fabricated almost immediately by using silicon micromachining [9]. AFM cantilevers have since then been continuously improved and are now standard commercial products [10]. The availability of such small cantilever structures sensitive to very small forces, in which the deflection can be accurately monitored by the standard AFM equipment, has triggered their use as transducers for physical and chemical measurements [11]. In particular, in the past few years they have been used for biochemical sensing by various methods [12,13]. In this paper we briefly review the application of micro- and nano-electromechanical systems (MEMS-NEMS) for [bio]chemical analysis, with emphasis on devices based on microcantilever structures. We will not discuss the use of the AFM in its standard configuration, but we will cover the particular case in which standard AFM cantilevers are used as MEMS devices. A comprehensive review of the field of cantilever transducers for chemical and biological sensors can be found in a recent paper by Lavrik et al. [14]. In section 2 we discuss the basic behaviour of micro-nano cantilevers and

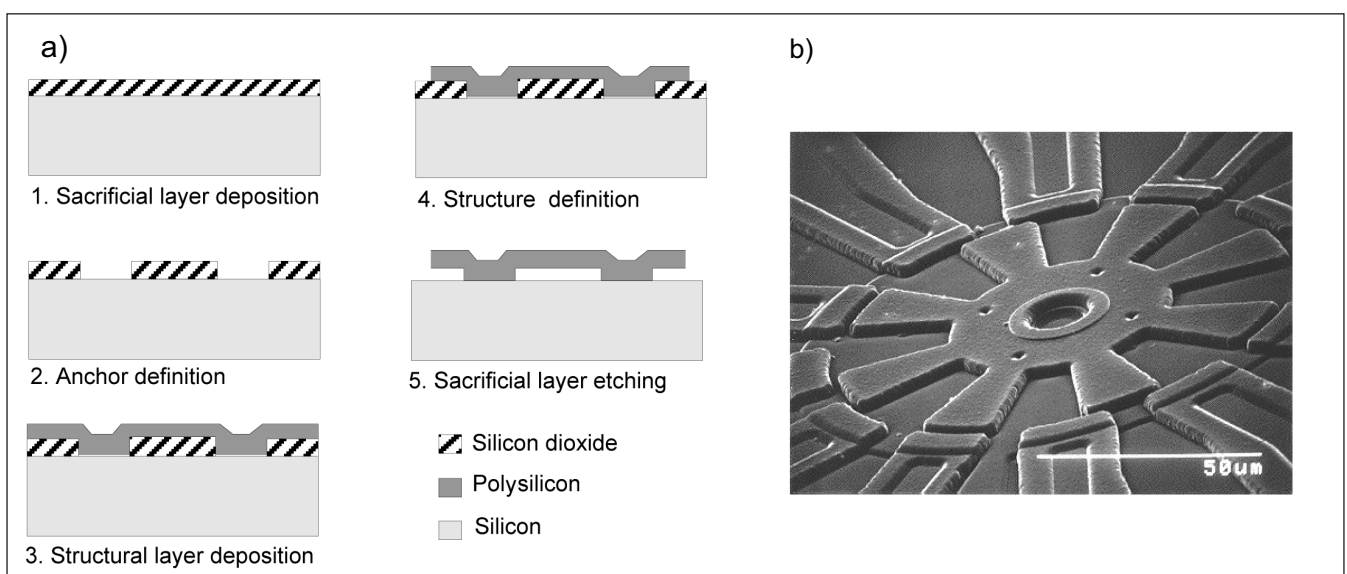

Figure 3. Silicon surface micromachining. a) Schematic view in cross section of the micromachining process. b) Example of a surface micromachined structure: a polycrystalline silicon electrostatic micromotor fabricated at CNM.

their use as detectors of [bio]molecules. Section 3 discusses the conversion from mechanical signals to electrical signals. In section 4 we present a number of specific applications of MEMS-NEMS transducers for [bio]molecular analysis.

## 2. Mechanical structures as [bio]molecular detectors

Micromechanical structures can be used for the measurement of mechanical properties, and in particular for the measurement of forces. One of the simplest structures is a cantilever beam with one fixed end and one free end. If a force  $F$  is applied at the free end perpendicularly to the beam (Fig. 4.a), the classical beam theory for small deformations can be used to calculate the deflection  $z$  of the cantilevered end. Assuming a rectangular cross section of width  $w$  and thickness  $h$ , the result is

$$z = \frac{4L^3}{Ewh^3}F \quad (1)$$

where  $L$  is the cantilever length and  $E$  its Young's modulus. Figure 4.b shows the force required to produce a deflection equal to the cantilever thickness as a function of the cantilever length, for cantilevers with a fixed length and width to thickness ratio. It can be seen that cantilevers with a length of  $10 \mu\text{m}$  or less can be deflected by forces smaller than  $1 \text{ nN}$ . For (bio)molecular sensing one should be able to detect the forces involved in chemical bonding and intermolecular interactions [15]. The forces required to break a covalent

bond are the strongest. The energy involved is of the order of  $1 \text{ eV}$  (i.e.,  $1.6 \times 10^{-19} \text{ J}$ ) and the typical length is about  $1 \text{ \AA}$ . The resulting force, simply calculated as the energy divided by the length, is  $1.6 \text{ nN}$ . Van der Waals interactions between molecules have typically one-tenth this energy on ten times this distance [16], thus resulting in a force of about  $16 \text{ pN}$ . Typical ligand-receptor interactions involve breaking and rearrangement of a number of van der Waals, hydrogen or ionic bonds, plus stretching of covalent bonds [15]. This entails total energies of about  $1 \text{ eV}$  over distances of  $1 \text{ nm}$ , thus resulting in forces of  $1 \text{ eV/nm} = 160 \text{ pN}$ . These are indeed the typical forces required to break receptor-ligand bonds [17,18], to unfold protein molecules [19,20] and to separate DNA strands [21]. [Bio]molecular detection would therefore require the ability to perceive forces of about  $100 \text{ pN}$ . The required cantilever dimensions can be envisaged from Fig. 4.b, although it has been calculated for a cantilever with specific length and width to thickness ratios. A force of  $100 \text{ pN}$  would deflect a cantilever with about  $10 \mu\text{m}$  length,  $1 \mu\text{m}$  width and  $100 \text{ nm}$  thickness. It can be seen however from (1) that for a given thickness, longer and narrower cantilevers would require smaller forces to achieve the same bending. Thus the fabrication of nanomechanical structures with submicron feature sizes (NEMS) would be an advantage for [bio]molecular detection. Various nanofabrication methods are available to define nanomechanical structures with lateral dimensions of the order of  $100 \text{ nm}$ . These include electron beam lithography [22], scanning probe lithography [23], nanoimprint lithography [24] and focused ion beam [25]. These are complemented with accurate reactive ion etching processes. Precisely defined nanomechanical structures have been fabricated by using a combination of these processes [26, 27, 28].

While any micro- or nano-mechanical structure can in principle be used for molecular detection, the simpler structures, such as doubly supported beams and singly supported cantilevers, are favoured. Doubly supported beams (bridges) are mechanically more stable and robust than cantilevers, but they are less deformed by the same applied force, thus making more difficult to detect the deflection. For this reason, cantilever structures are almost exclusively used in micromechanical based [bio]chemical sensors [14]. The [bio]molecular sensing is achieved by detecting chemical interactions between molecules on the cantilever surface and molecules in the chemical solution. Two basic detection methods are used: static and dynamic.

The static method is based on the fact that a cantilever structure will bend when its mechanical stress is not uniform along its thickness (Fig. 5.a). Specifically, static molecular detection is based on an asymmetric coating of the cantilever surfaces, which is typically achieved by coating a single surface. If a coating on the upper surface has a compressive stress, it will tend to expand and the cantilever will bend downwards (Fig. 5.b). The coating layer stress may change by physical adsorption or chemical bonding of the analyte molecules [29] (Fig. 5.c) or by permeation of the analyte molecules leading to coating swelling (Fig. 5.d). If  $\Delta\sigma$  is the sur-

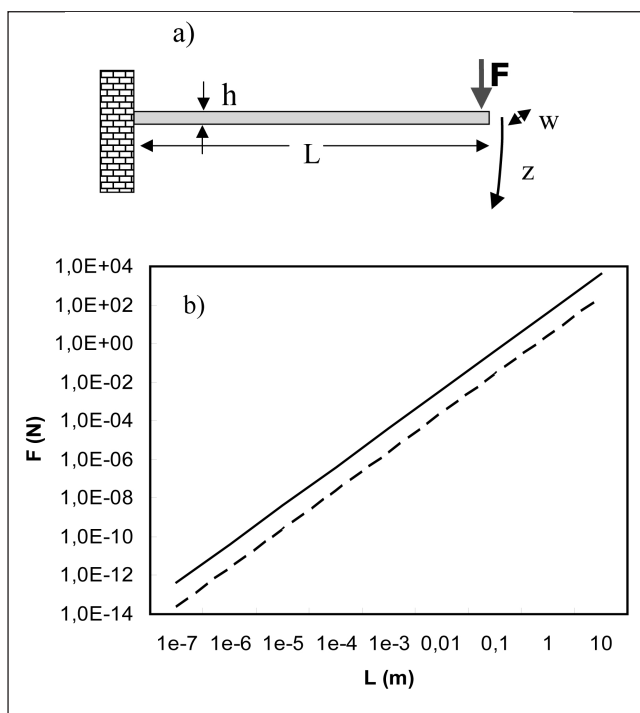

Figure 4. a) Schematic view of a cantilever beam. b) Force required to obtain a cantilever deflection equal to its thickness  $h$ , for cantilevers with  $L=100h$  and  $w=10h$ , as a function of  $L$ . Continuous line: silicon cantilever. Dashed line: polymer cantilever.

face stress change, the corresponding displacement of the cantilever tip will be

$$\Delta z = \frac{3L^2(1-\nu)}{Eh^2} \Delta\sigma \quad (2)$$

where  $\nu$  is Poisson's ratio. A related technique is based on detecting intermolecular forces by approaching and retracting a functionalised cantilever tip to a functionalised surface [30]. If specific molecules are present on the surface so that a ligand-receptor interaction between the tip and surface exists, the cantilever will bend during the retraction. This technique is called molecular force spectroscopy.

The dynamic method is based on modifying the resonance properties of a vibrating cantilever (Fig. 6.a). For small amplitudes, a vibrating cantilever is equivalent to a spring-mass system, in which a spring of spring constant  $k$  applies a force  $F=k \cdot x$  on a mass  $M$  when this is displaced a distance  $x$  from its equilibrium position. For a cantilever of rectangular cross section, the equivalent spring constant  $k$  is

$$k = \frac{Ewh^3}{4L^3} \quad (3)$$

When driven by a sinusoidal force of frequency  $f$ , the vibration amplitude reaches a maximum at the resonance fre-

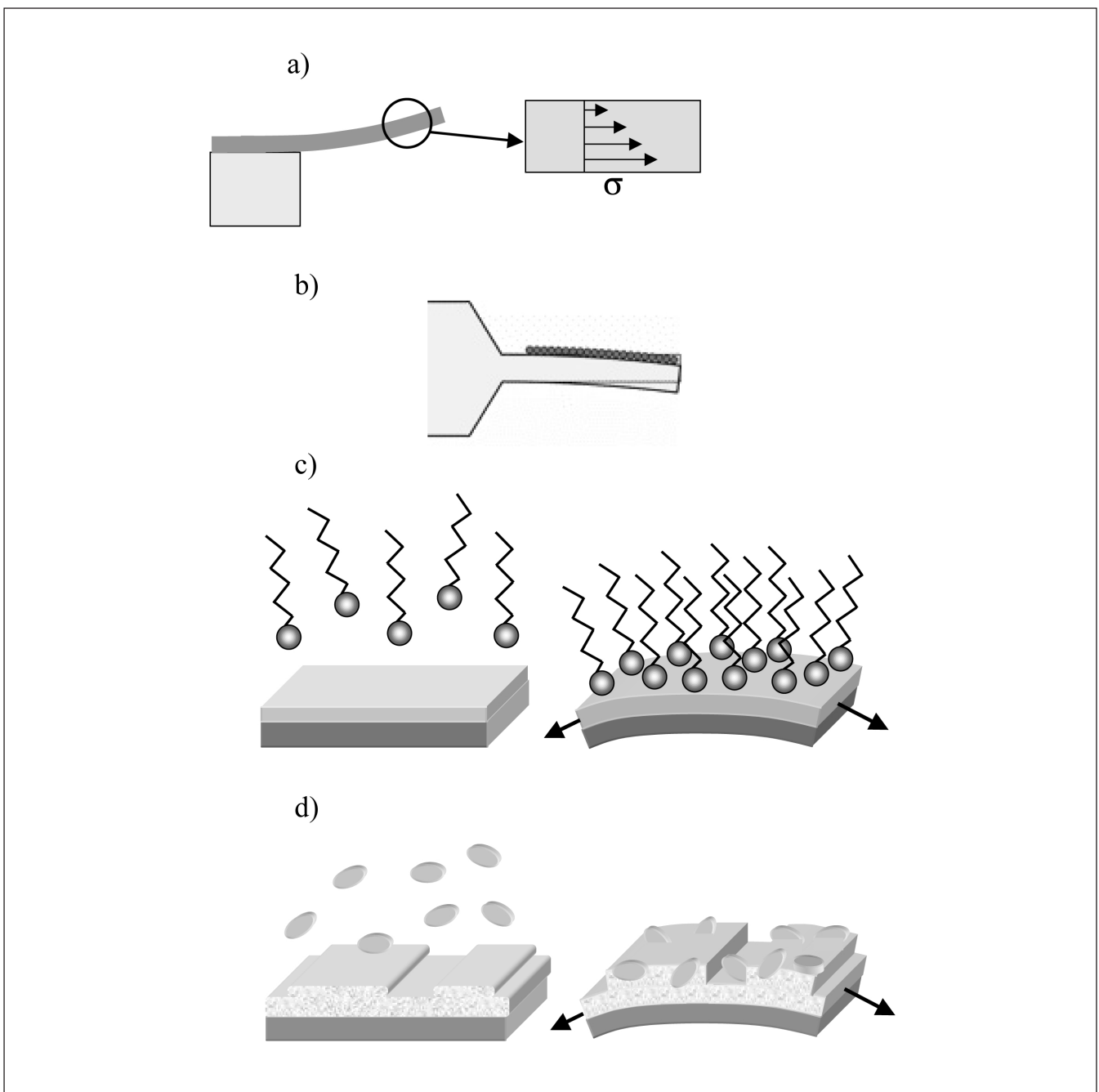

Figure 5. a) Schematic cross section of a cantilever with a non-uniform mechanical stress along its thickness. b) Schematic cross section of a cantilever with a compressive thin film coating in its upper surface. c) Change of the coating layer stress by physical adsorption or chemical bonding of molecules. d) Change of the coating layer stress by permeation of the analyte molecules producing coating swelling.

frequency  $f_0 = \sqrt{k/M}/(2\pi)$ . The frequency width of the resonance peak depends on the quality factor  $Q$ , which is related to the damping of the oscillator (Fig. 6.b). From this dependence of  $f_0$  on  $M$ , a change in the mass of the cantilever will result in a change in the resonant frequency. This makes a cantilever operated in the dynamic mode an extremely sensitive mass detector. A 30  $\mu\text{m}$  long cantilever with a width of 2  $\mu\text{m}$  and a thickness of 0.5  $\mu\text{m}$  would have a resonant frequency of 375 kHz and a sensitivity of about  $4 \times 10^{-16}$  g/Hz.

In any of the detection modes, a [bio]chemical sensor will only be sensitive if the mechanical deformation of the cantilever can be transformed into an electrical signal. To obtain an insight as to the deformations involved in [bio]chemical detection, Fig. 7 shows the static deformation of cantilevers with various sizes as a function of the force applied at the free end. One of the cantilevers has the “minimum” dimensions that can be achieved by the standard nanofabrication techniques (1  $\mu\text{m}$  length, 100 nm width and 10 nm thickness). It can be seen that this has a higher deflection than a cantilever with all three dimensions ten times greater. But this strongly depends on the cantilever dimensions and dimensional ratios, as an even bigger cantilever with typical micro-fabricated dimensions (50  $\mu\text{m}$  length, 5  $\mu\text{m}$  width and 200 nm thickness) is deflected in between the other two. It can be concluded from Fig. 7 that the typical deflections that can be expected for forces in the 100 pN range would be of the order of 1-10 nm. A challenge in cantilever-based [bio]chemical sensors is therefore the development of transducer elements (Fig. 1) able to obtain useful electrical signals from these displacement values.

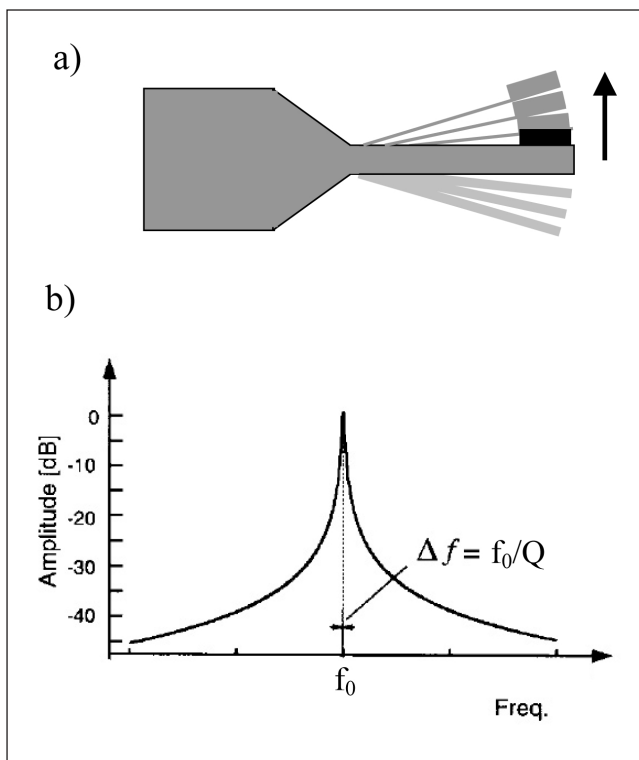

Figure 6. a) Schematic cross section of a vibrating cantilever with an attached mass. b) Vibration amplitude as a function of its frequency.

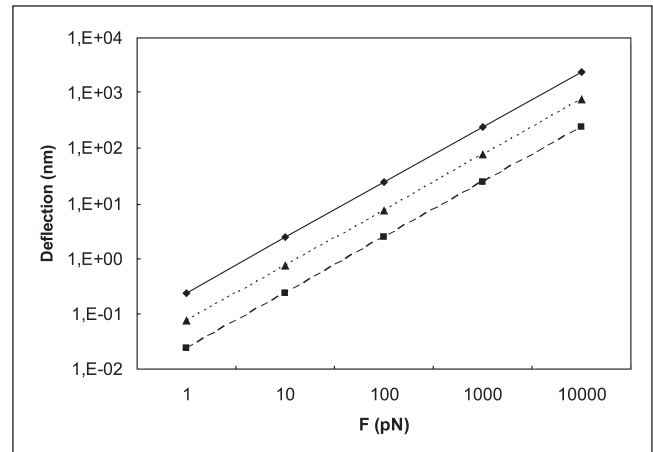

Figure 7. Static deformation of cantilevers with various sizes as a function of the force applied at the free end. Continuous line: length 1  $\mu\text{m}$ , width 100 nm, thickness 10 nm; dotted line: length 50  $\mu\text{m}$ , width 5  $\mu\text{m}$ , thickness 200 nm; dashed line: length 10  $\mu\text{m}$ , width 1  $\mu\text{m}$ , thickness 100 nm.

### 3. Electrical readout of mechanical signals

A number of transducing principles have been used over the years to convert mechanical displacements into electrical signals [31]. We briefly discuss here the most relevant and their applicability to cantilever-based [bio]chemical sensors.

The most widely used method to detect the (static or dynamic) deflection of cantilevers is based on an optical principle, as this is the method used in commercial AFM instruments. The cantilever deflection is monitored by measuring the position of a laser beam deflected by the cantilever [32] (Fig. 8.a). This measurement method is extremely sensitive, but it requires a light reflecting surface on the cantilever and a minimum reflecting area, and thus it cannot be used for nanocantilevers (specifically, it loses efficiency for cantilevers narrower than about 5  $\mu\text{m}$ ). The need for a laser source and a detector separated a minimum distance from the cantilever makes it difficult to miniaturise the system, which would be a problem for the development of portable sensor systems.

The capacitive principle has been extensively used to detect the movement of micromechanical structures in MEMS sensors such as accelerometers [33]. It is based in detecting the variation of the capacitance on a two-electrode capacitor, where one electrode is fixed and the other is in the mobile structure (Fig. 8.b). An intrinsic problem of its use in micro- and nano-cantilevers is that the small dimensions involved result in extremely small capacitance values and in even smaller capacitance variations due to deflection. For a parallel plate capacitor, the capacitance is given by  $C = \epsilon A/d$ , where  $\epsilon$  is the permittivity of the dielectric medium between the electrodes,  $A$  is the electrode area and  $d$  the electrode separation. For a 100  $\mu\text{m} \times 2 \mu\text{m}$  cantilever with an electrode gap of 50 nm, the capacitance in air is  $4 \times 10^{-14}$  F, or 40 fF. As the typical values of the parasitic capacitances of electrical wires are of the order of pF, two orders of magnitude greater, it is clear that useful measurements can only be achieved in this case if the cantilever signal is immediately amplified by integrated signal processing

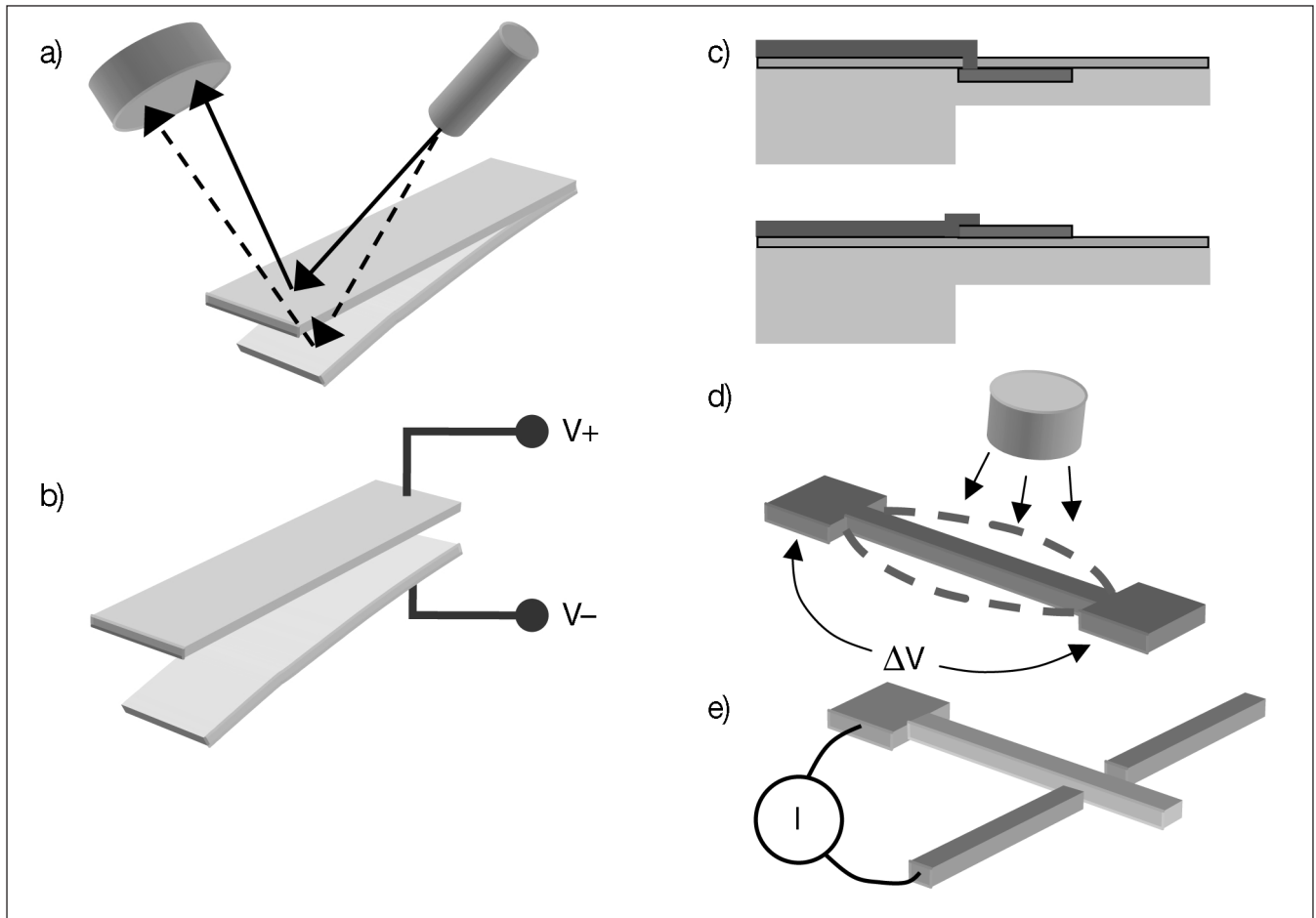

Figure 8. Methods of transduction between mechanical signals and electrical signals. a) Optical method; a laser emitter and a photodiode detector are used. b) Capacitive method; the upper electrode is fixed but the lower one can move. c) Piezoresistive method; cantilever cross sections are shown; top: resistor on the bulk material; bottom: resistor on a thin film. d) Magnetomotive sensing; the electrical potential induced by the movement of a current carrying conductor on a magnetic field is measured. e) Electrical (tunnel) current method; the current between the conducting cantilever and a fixed electrode is measured.

circuits in the same chip. The need to have a fixed electrode at a very short distance from the moving cantilever imposes additional constraints to the use of the capacitive method.

The piezoresistive principle has also been widely used in MEMS such as pressure sensors and accelerometers [34]. It consists in the variation of the resistivity (and thus the electrical resistance) of a conductor exposed to mechanical stress. This effect is specially strong in semiconductors such as silicon and for this reason it has a direct applicability in MEMS/NEMS devices. To detect the deflection of a cantilever, a resistor must be located on one of its surfaces, where the mechanical stress is maximum. The whole cantilever thickness cannot be used for the piezoresistor, as the mechanical stress due to bending has opposite signs in opposite surfaces, so that when integrated over the cantilever thickness it averages to zero. The resistor can be integrated on the bulk material or located on a thin film over its surface (Fig. 8.c).

A related method is based on piezoelectric materials, in which an electric field is generated when a mechanical stress is applied. Practical problems, however, restrict the use of piezoelectric materials in micro- and nano-mechanical structures. Typically relatively large film thicknesses are needed for a good sensitivity, and the required materials (e.g. ZnO) are not standard in microelectronics technology.

One transducing method based on electromagnetic principles is very efficient for small structures. When a conductor carrying an electric current is moving in a constant magnetic field, an electromotive force (i.e. an electric potential) is induced in the conductor (Fig. 8.d). This method, known as magnetomotive sensing, requires a relatively strong magnetic field and a conducting moving structure such as a bridge, but it is very sensitive for NEMS structures [26].

Finally, the cantilever movement can be detected with a very high sensitivity by measuring the electrical (tunnel) current between the (conducting) cantilever and a fixed conducting electrode [35]. The fixed electrode can be located, for example, on one side of the cantilever (Fig. 8.e). The main challenge of this measurement method is that the distance between the cantilever and the fixed electrodes should be very small, ideally about 10 nm.

Whatever transducing principle is used for converting the mechanical displacements into an electrical signal, the minimum value of the force that can be measured, and therefore the minimum concentration of analyte that can be detected, would be a compromise between the cantilever sensitivity and inherent noise. The sensitivity of a sensor system is defined as the magnitude of the output signal per unit of input signal. This may be in our case the force sensitivity  $\Delta V/\Delta F$  or the chemical sensitivity

$\Delta V/\Delta pX$ . The noise is defined as any uncontrolled fluctuation of the output signal  $\Delta V_{noise}$ . The resolution of a sensor system is defined as the minimum input signal that can be detected, and is given by the ratio between the noise and the sensitivity. In our case this would be the minimum force or chemical activity that can be detected (e.g.  $Res]_F = \Delta V_{noise} / (\Delta V/\Delta F) = \Delta F_{min}$ ). Force and mass sensitivities in terms of beam deflection and resonance frequency shift for static and dynamic measurements, respectively, have been discussed in section 2. The final sensor sensitivity, however, would depend on the particular transducing principle used. Many factors influence the noise values in micro- and nano-mechanical cantilevers. Its detailed study is out of the scope of this paper, but we will discuss some of the main sources of noise. Some of them are common for all cantilever types, but others depend on the transducing principle used.

A noise component that is ubiquitous in all cantilevers is the thermomechanical noise, arising from the thermal equilibrium between the cantilever and its environment (air or liquid). Essentially, the cantilever is subjected to random motion due to the interaction with the randomly moving surrounding molecules. The same coupling between the cantilever and the medium is responsible for the damping (i.e. energy dissipation) of the cantilever motion and therefore for its quality factor value  $Q$ . The effect can be calculated from the equipartition theorem of statistical physics, from which the mean-square noise displacement  $\langle x^2 \rangle$  of each mode of oscillation of the cantilever, taken as a spring-mass system, would be given by

$$\frac{1}{2}k_B T = \frac{1}{2}k \langle x^2 \rangle \quad (4)$$

where  $k_B$  is Boltzmann's constant and  $T$  is the absolute temperature. From this it results that the displacement noise for a bandwidth  $B$  is [36]

$$x_{min} = \sqrt{\frac{4k_B T B}{\omega_0 k Q}} \quad (5)$$

in terms of the resonant angular frequency  $\omega_0$ . From (5) it is clear that a large  $Q$ , i.e. a small damping, leads to a small displacement noise, and therefore to a high resolution. The effect of the thermomechanical noise can also be calculated in terms of a frequency fluctuation instead of a displacement fluctuation [37], which is useful for cantilevers operating in the dynamic mode.

Temperature fluctuations also affect all types of cantilever sensors. Other noise sources are relevant for particular transducer implementations. For example, optical approaches would be influenced by fluctuations on the light source, and magnetomotive approaches by fluctuations on the magnetic field. In electrical conductors, two noise sources are specially important, and these influence all transducing methods involving electrical currents, i.e. all methods except the optical one. They are particularly significant in piezoresistive cantilevers [38,39]. The thermal or Johnson-Nyquist noise is independent of the frequency, and is due to thermal fluctuations on the energy of the carriers transporting the electrical current in a resistor  $R$ . The mean square voltage fluctuation is

given by  $\langle V_{JV}^2 \rangle = 4k_B T R B$ . At low frequencies resistors also show conductance fluctuations, usually called 1/f noise because the mean square fluctuation has this dependence on the frequency. It is not completely understood whether the origin of the 1/f noise is due to fluctuations in the number of carriers (due to generation-recombination traps, for example) or to mobility fluctuations, or both. In any case its mean square voltage fluctuation has been empirically found to be related to the total number of carriers  $N$  in the resistor [39] as

$$\langle V_{VF}^2 \rangle = \frac{\alpha V^2}{f N} \quad (6)$$

where  $V$  is the voltage across the resistor and  $\alpha$  is a dimensionless empirical parameter, which typically has values between  $10^{-6}$  and  $10^{-4}$ .

Figure 9 shows an example of the output response, noise and resolution for a piezoresistive cantilever with the geometry shown in the figure inset and a fixed thickness of 200 nm, as a function of its length and width, for an applied 100 pN force.

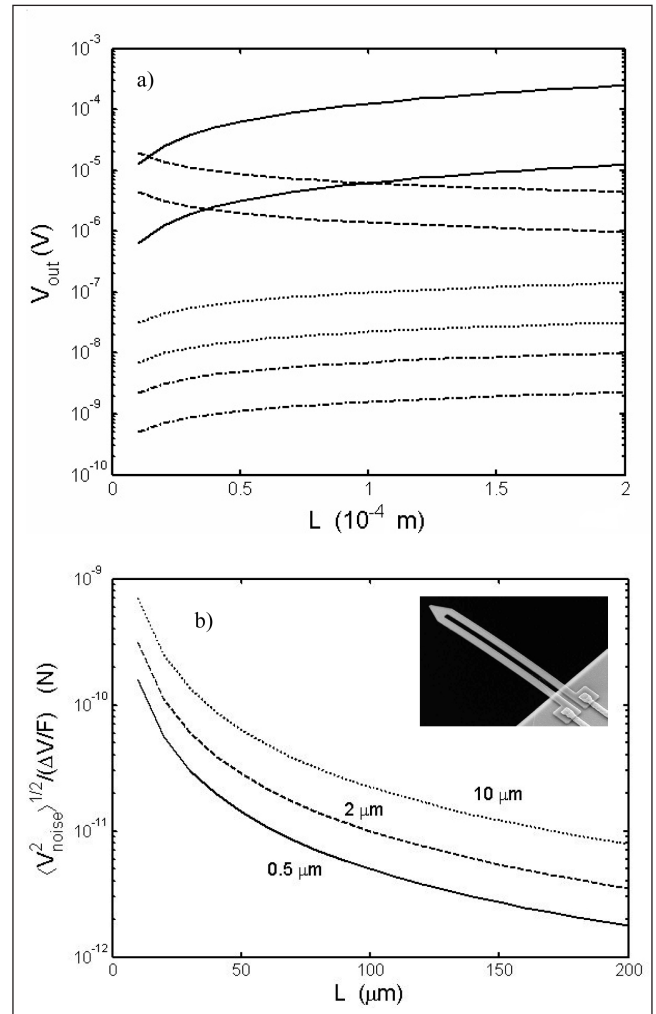

Figure 9. a) Output response and noise for a piezoresistive cantilever with the geometry shown in the figure inset in (b) and a thickness of 200 nm, as a function of its length and width. The applied force is 100 pN. Upper lines are for a width of 500 nm; lower lines are for a width of 10  $\mu\text{m}$ . Continuous lines: output value; dashed lines: 1/f noise; dotted lines: Johnson-Nyquist noise; dashed-dotted lines: thermomechanical noise. b) Resolution obtained from the results in (a) for three cantilever widths.

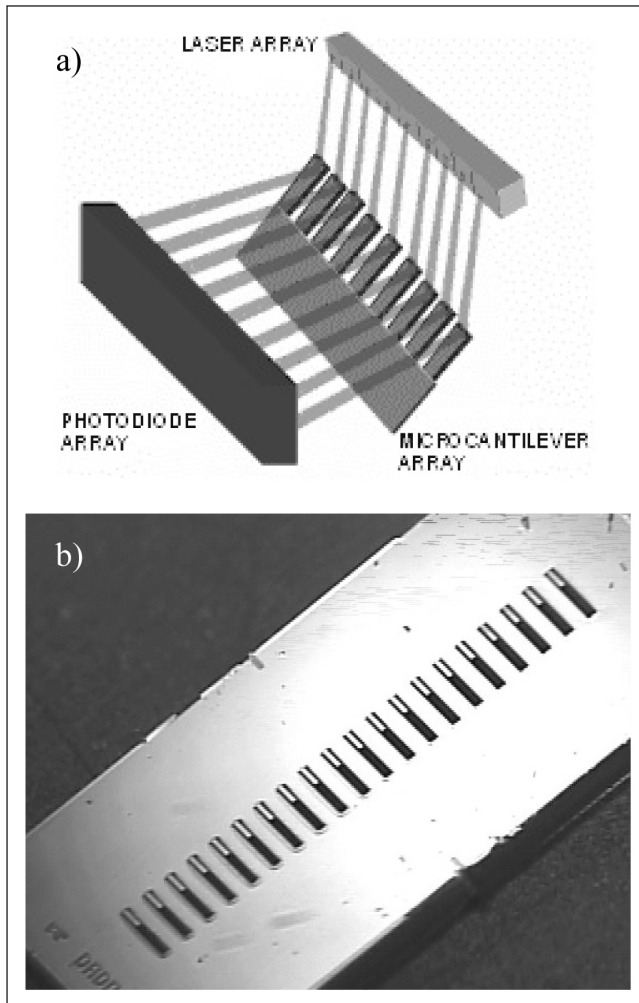

Figure 10. a) Schematic view of cantilever arrays integrated with laser emitters and photodiode receptors in a hybrid miniaturised electronic system. b) Photograph of the cantilever array. The cantilevers are only partially visible at this magnification.

From these results, a resolution of 10 pN would be in principle attainable. It can also be seen that the resolution increases (i.e. has a smaller value) for longer and narrower cantilevers, but this cannot be directly extended to cantilevers based on other transducing principles.

#### 4. Applications

The use of micro- and nano-mechanical structures based on cantilevers in [bio]chemical analysis applications has increased significantly during the last few years. We can only present here some specific examples. For a more comprehensive treatment, the reader is referred to refs. [14] and [40].

One of the first applications of biochemically induced surface stress in nanomechanics for molecular recognition was reported by Fritz et al. [13]. They achieved the specific recognition of DNA molecules and proteins. They used a static measurement and an optical transducing method on silicon cantilever arrays. The cantilevers had 1  $\mu\text{m}$  thickness, 500  $\mu\text{m}$  length and 100  $\mu\text{m}$  width. Different thiol-modified 12-mer oligonucleotides were immobilised on gold

on the cantilever surfaces. The cantilever bending was detected after injection of complementary oligonucleotides. With a differential measurement between two cantilevers, a difference of one base on the 12-mer oligonucleotides was detectable.

One of the drawbacks of the optical detection methods is the difficulty in miniaturizing the complete optical system. Zinoviev et al. [41] have fabricated cantilever arrays to be integrated with laser emitters and photodiode receptors in a hybrid miniaturised electronic system (Fig. 10.a). This opens the way to obtaining small analytical systems based on static cantilever deflection and optical detection. The cantilevers (Fig. 10.b), with typical dimensions of 200  $\mu\text{m}$  length, 40  $\mu\text{m}$  width and 340 nm thickness, are intended for DNA analysis.

Protein detection has also been achieved by the specific binding of proteins into cantilever surfaces. As an example, Raiteri et al. [40] used silicon nitride cantilevers in which one side was coated with 40 nm of gold. A monolayer of two types of thiols was then formed on the gold layer. The longer thiol chains were biotinylated (Fig. 11.a). When adding 0.1  $\mu\text{M}$  (about 6  $\mu\text{g}/\text{ml}$ ) streptavidin into a flow of phosphate buffer saline solution (pH 7.4), the cantilevers bent down (Fig. 11.b), corresponding to a compressive stress in the biotinylated side. The bending was detected optically. Tests with BSA protein showed that the effect was largely due to the affinity interaction between streptavidin and biotin.

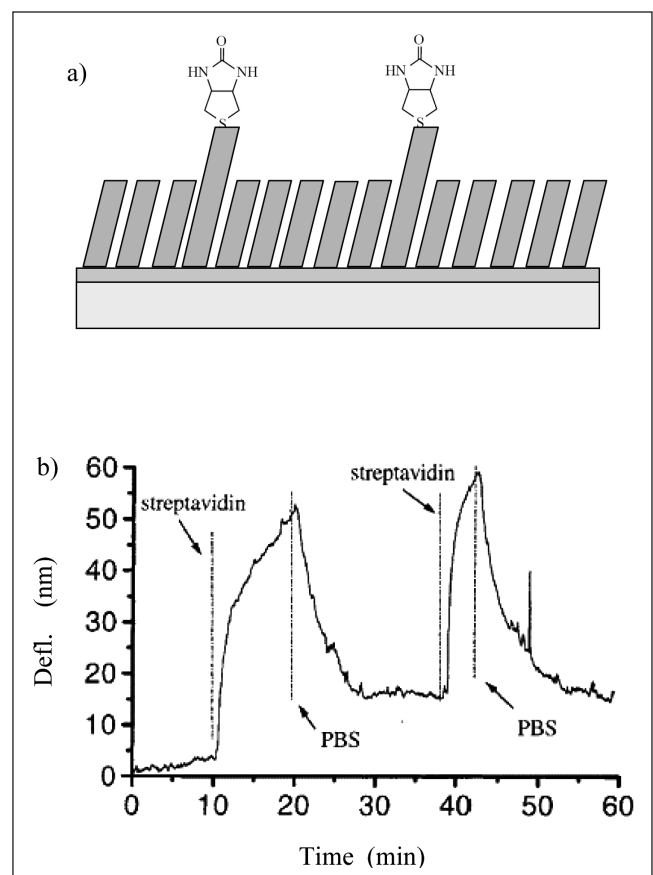

Figure 11. a) Schematic cross section of a gold-coated cantilever to which two types of thiol chains have been bonded. The longer chains are biotinylated. b) Results when streptavidin or buffer solution are added to the cantilevers. (Adapted from ref. [40]).



Microcantilevers are not only useful for the analysis of large molecules. They have also been applied to the detection of ions. Ji et al. [42] selectively detected caesium ions in the presence of high concentrations of potassium and sodium ions. The receptor molecule 1,3-alternate 25,27-bis(11-mercapto-1-undecanoxyl)-26,28-calix[4]benzo-crown-6 was co-absorbed with decane-1-thiol on the gold surface of a microcantilever (Fig. 12.a) by the self-assembled monolayer method. A commercial AFM cantilever was used, and its static deflection was measured optically. A sensitivity several orders of magnitude better than the available ion selective electrodes was obtained. Fig. 12.b shows the cantilever bending response. It can be seen that the sensitivity and selectivity towards potassium was higher in the range  $10^{-11}$ - $10^{-8}$  M. The crown cavity of the receptor molecule was the reason for the high selectivity towards  $\text{Cs}^+$ .

In contrast to the optical detection methods that are used in the above examples, electrical transducing methods facilitate the miniaturization of the measurement systems.

Hagleitner et al. [43] fabricated silicon piezoresistive cantilevers integrated with signal-processing circuits, as part of a gas multisensor microsystem. The cantilever sensor was based on the dynamic method to measure the mass change due to absorbed gas molecules on a polymer layer. The cantilever dimensions were about  $150\ \mu\text{m}$  length and width, and  $5\ \mu\text{m}$  thickness, and the chip contained a feedback oscillation circuit that was used to keep the cantilever in resonance (using

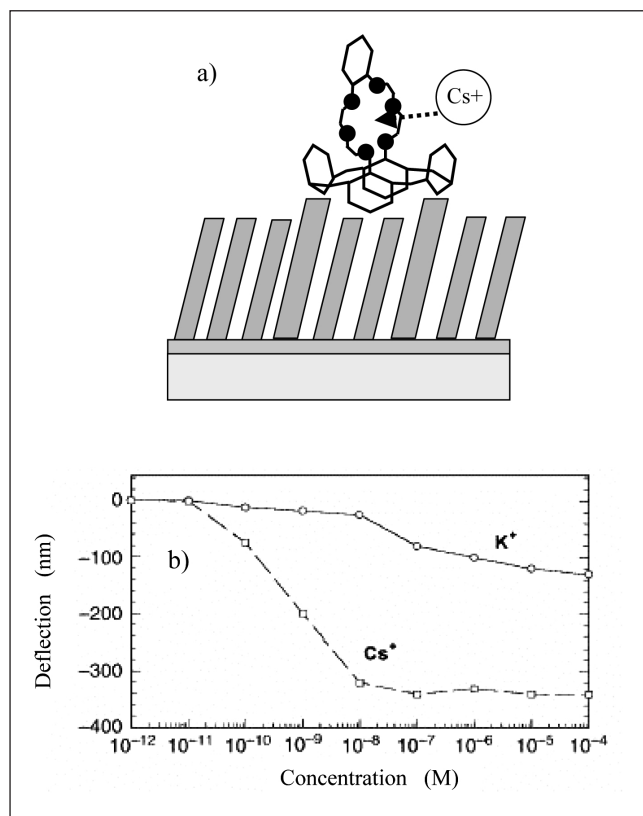

Figure 12. a) Schematic cross section of a gold-coated cantilever to which two types of molecules with thiol chains have been bonded. One of the thiol types is bonded to 1,3-alternate calix[4]benzocrown-6, which contains a cavity well adapted for  $\text{Cs}^+$ . b) Cantilever deflection as a function of the  $\text{Cs}^+$  or  $\text{K}^+$  concentration. (Adapted from ref. [42]).

heating resistors) and to measure the resonance frequency. It achieved a detection limit of about 1 ppm for toluene. Researchers from the same group at ETH Zürich are currently developing integrated piezoresistive cantilevers in the same dimensional range for detecting either static deflections or dynamic resonance frequency shifts for measurements in liquids, intended for protein analysis [44]. In both cases the chips include signal amplification and analog to digital conversion, so that a digital output is provided. Preliminary measurements have given a sensitivity of  $0.8\ \mu\text{V}/\text{nm}$  per volt of applied bias in the static system.

As discussed in section 2, a cantilever operated in the dynamic mode is sensitive to very small mass variations. Ghatnekar-Nilsson et al. [45] have developed nanoresonators that are driven into resonance by electrostatic methods and measured by capacitive detection. The cantilevers are fabricated so that they oscillate in the plane of the chip (Fig. 13.a). The small capacitances involved require the integration of signal-processing circuits, which are mainly a low-noise amplifier, in the same chip (Fig. 13.b). The  $2.5\ \mu\text{m}$  CMOS integrated circuit fabrication technology of CNM has been used. The cantilevers (Fig. 13.c)

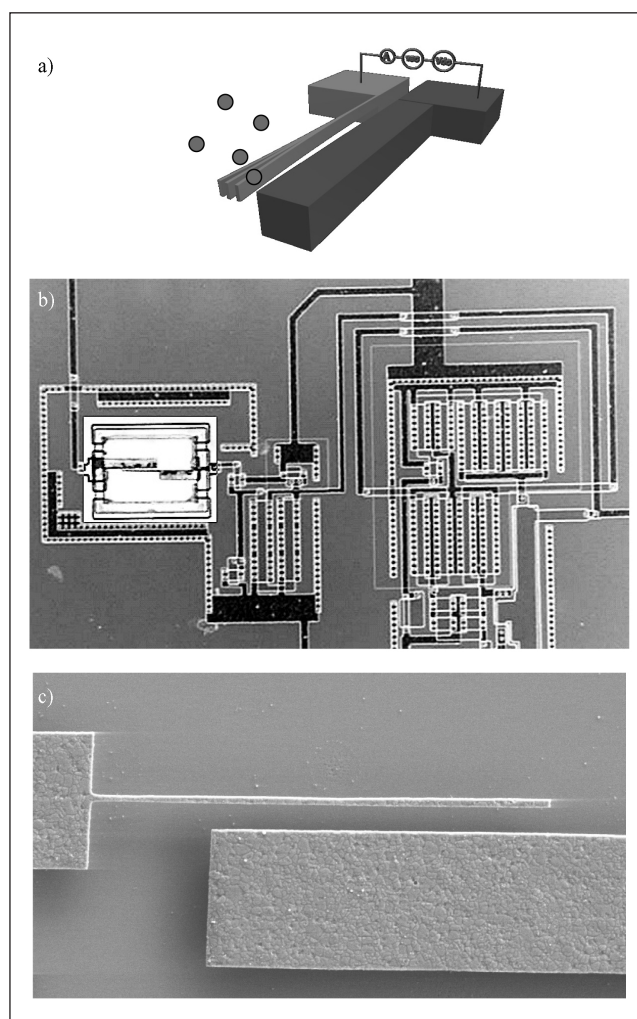

Fig. 13. a) Schematic view of electrostatically excited and capacitively measured nanocantilevers. b) Photograph of one part of the silicon chip, containing the nanofabricated area (bright rectangle on the left) and the amplifier circuit (central and right areas). c) SEM micrograph of one nanocantilever.

are made of polycrystalline silicon, and have dimensions of 420 nm width, 600 nm thickness and 20  $\mu\text{m}$  length. The resulting calculated mass sensitivity  $\partial m/\partial f$  is 17 ag/Hz, or  $1.7 \times 10^{-17}$  g/Hz. Similar cantilevers fabricated in crystalline silicon with different dimensions (600 nm width, 5  $\mu\text{m}$  thickness and 40  $\mu\text{m}$  length) have been tested by electrostatically attaching latex spheres to them. One sphere, with 1  $\mu\text{m}$  diameter, has a weight of 549 fg. The corresponding resonance frequency shift was measured to be 2 kHz [46], which results in a sensitivity of about 270 ag/Hz.

As a specific example of the sensitivity of resonating cantilevers and their application to the detection of biochemical entities, Gupta et al. [47] used silicon cantilevers in the range of 4–5  $\mu\text{m}$  in length, 1–2  $\mu\text{m}$  in width and 20–30 nm in thickness to detect individual virus particles. The cantilever oscillations were excited by the thermal and ambient noise, without an external source, due to the small dimensions of the cantilevers and the sensitivity of the measurement setup. The frequency spectra of the cantilevers were measured before and after incubation of vaccinia virus particles. The resonance frequency shift was then correlated to the number of virus particles on each cantilever, determined by direct SEM observation. It was found that a single virus particle (9.5 fg on average) produced a 60 kHz shift, resulting in a sensitivity of 0.16 ag/Hz.

In order to detect protein molecules by using molecular force spectroscopy (Fig. 14.a) in portable instruments, we are developing cantilevers with piezoresistive detection [48]. To minimize the cantilever width, a U-shaped structure has been

used (Fig. 14.b), in which the piezoresistor goes through the complete surface of the cantilever. A lower structural layer of 400 nm thick polycrystalline silicon is separated by 30 nm of silicon dioxide from an upper 200 nm thick polycrystalline silicon layer which acts as the piezoresistor. The calculated resolution would be that of Fig. 9.b multiplied by a factor of about 10, which is the square of the ratio of the cantilever thicknesses in both cases. Cantilevers have been fabricated with lengths between 60 and 200  $\mu\text{m}$  and leg widths between 2 and 10  $\mu\text{m}$ . The corresponding spring constants (3) range from 1.02 to 0.006 N/m. The cantilever sensitivity has been measured by applying a known displacement with an AFM tip. For a 200  $\mu\text{m}$  long and 2  $\mu\text{m}$  wide cantilever, the result was 1  $\mu\text{V}/\text{nm}$  for a 5 V bias applied in a voltage divider configuration with a reference resistor. This would produce an output of 1.7  $\mu\text{V}$  for an applied force of 10 pN. To obtain an adequate output from the cantilever-based sensor, the cantilevers have also been fabricated with an integrated amplifier circuit. For this the polycrystalline silicon layers of the CMOS integrated circuit process have been used to fabricate the cantilevers (Fig. 14.c). Figure 14.d shows the fabricated integrated cantilevers and circuits.

## 5. Conclusions

Micro- and nano-mechanical structures fabricated by using silicon micromachining technology have been increasingly used in

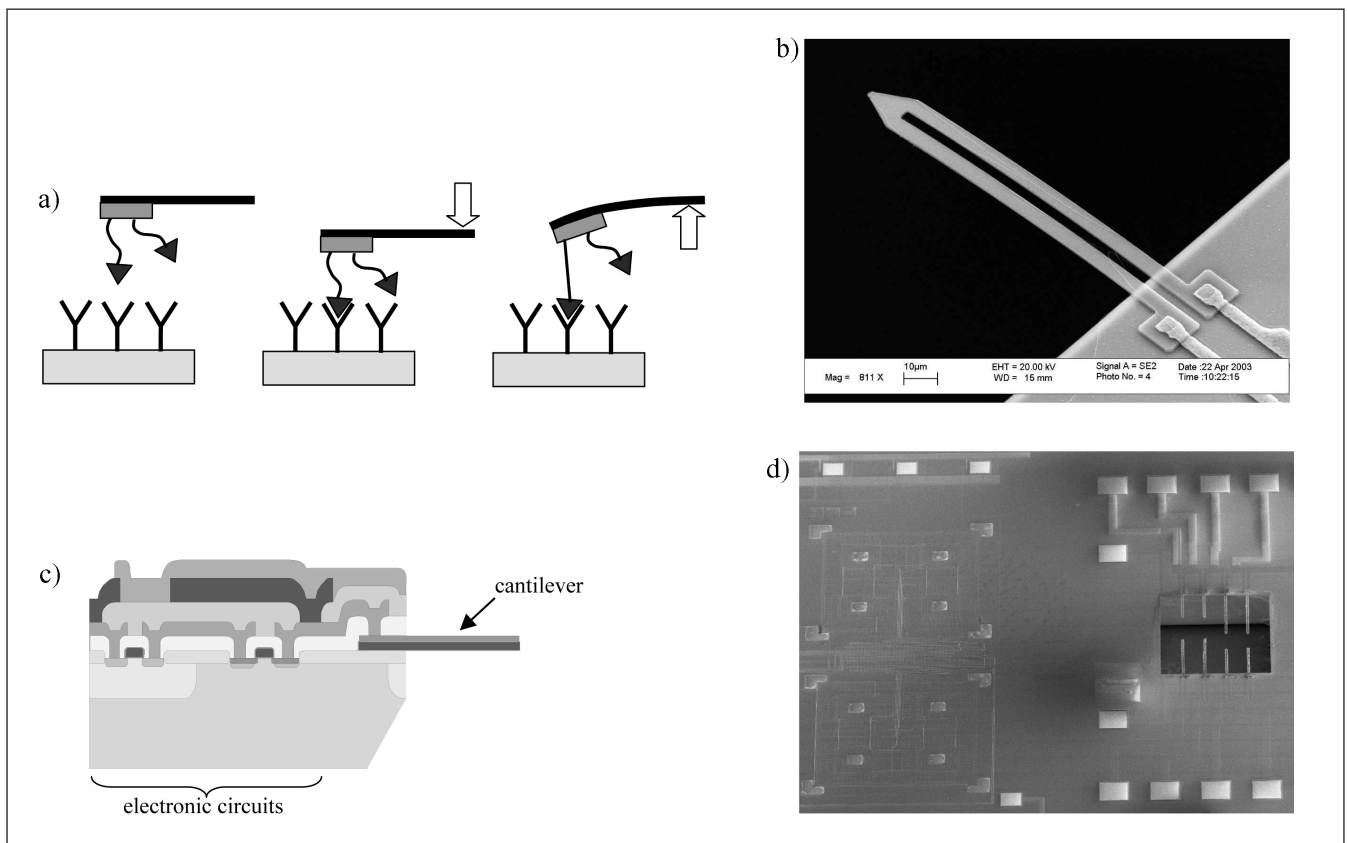

Fig. 14. a) Schematic view of the force spectroscopy measurement principle. A functionalised cantilever is approached to a surface and retracted. If a receptor-ligand bond is formed, the cantilever is deflected upon retraction. b) SEM micrograph of a piezoresistive cantilever (100  $\mu\text{m}$  length, 10  $\mu\text{m}$  leg width, 650 nm thickness). c) Schematic cross section, and d) SEM micrograph, of a piezoresistive cantilever and electrical circuits fabricated by a CMOS process.

the last few years as transducing elements in [bio]chemical sensors. This has been triggered by the development and availability of silicon microcantilevers as AFM probes. Cantilever beams with lengths in the tens of micrometers range and widths and thickness in the micrometer or submicrometer range are affected by forces in the range of intermolecular forces. This may result in static deflections or in shifts of the resonance frequency of the cantilever. In either case the cantilever modifications can be detected by optical or electrical methods and converted to an electrical output. The main factors that influence the overall sensitivity and resolution of the resulting [bio]chemical sensors have been discussed. The cantilever response and sensitivity depend on its dimensions, structure and material properties. The sensor resolution strongly depends on the properties of the transducing element that is used to convert the cantilever deflection into an electrical signal, and in particular on its noise behaviour. By discussing a number of specific examples, it has been shown that very high resolutions can be obtained by these methods, leading in some cases to the capability of detecting single biomolecular entities, such as virus particles. The integration of cantilever arrays in one chip and with signal processing electronic circuits, which can be mass fabricated by using microelectronics technology, opens the way to a new class of miniaturised [bio]chemical analysis systems.

## Acknowledgements

This work has been partially supported by the European Commission through project IST2001-34544 (BioFinger) and by "Ministerio de Educación y Ciencia" through project TEC2004-06514-C03-03/MIC. The author acknowledges the contributions of his colleagues and students from the Nanotechnology Group of CNM, and specially Prof. J. Esteve, Dr. F. Pérez-Murano, Dr. J.A. Plaza, Dr. J. Montserrat, C. Martín, G. Rius and G. Villanueva.

## References

- [1] Gopel W. and Schierbaum K.-D. (1991), Definitions and typical examples, in Göpel W., Hesse J. and Zemel J.N., Eds., *Sensors*, vol. 2, Chemical and biochemical sensors, VCH, Weinheim, Germany, p. 1–27.
- [2] Janata J., Josowicz M. and De Vaney D.M. (1994), *Chemical sensors*, Anal. Chem. 66: 207R–228R.
- [3] Petersen K.E. (1982), Silicon as a mechanical material, Proc. IEEE 70:420–457.
- [4] Kovacs G.T.A., Maluf N.I. and Petersen K.E. (1998), Bulk micromachining of silicon, Proc. IEEE 86:1536–1551.
- [5] Bustillo J.M., Howe R.T. and Muller R.S. (1998), Surface micromachining for microelectromechanical systems, Proc. IEEE 86:1552–1574.
- [6] Bausells J., Carrabina J., Merlos A., Bota S. and Samitier J. (1997), Mechanical sensors integrated in a commercial CMOS technology, *Sensors and Actuators A* 62:698–704.
- [7] Plaza J.A., Esteve J. and Lora-Tamayo E. (1998), Simple technology for bulk accelerometer based on bond and etch back silicon on insulator wafers, *Sensors and Actuators A* 68:299–302.
- [8] Binnig G., Quate C.F. and Gerber Ch. (1986), Atomic force microscope, *Phys. Rev. Lett.* 56:930–933.
- [9] Albrecht T.R. and Quate C.F. (1987), Atomic resolution imaging of a nonconductor by atomic force microscopy, *J. Appl. Phys.* 62:2599–2602.
- [10] See e.g. [www.veecoprobes.com](http://www.veecoprobes.com)
- [11] Wachter, E.A. and Thundat, T. (1995), Micromechanical sensors for chemical and physical measurements, *Rev. Sci. Instrum.* 66:3662–3667.
- [12] Lang H.P., Hegner M, Meyer E. and Gerber Ch. (2002), Nanomechanics from atomic resolution to molecular recognition based on atomic force microscopy technology, *Nanotechnology* 13:R29–R36.
- [13] Fritz J., Baller M.K., Lang H.P., Rothuizen H., Vettiger P., Meyer E., Güntherodt H.-J., Gerber Ch. and Gimzewski J.K. (2000), Translating biomolecular recognition into nanomechanics, *Science* 288:316–318.
- [14] Lavrik N.V., Sepaniak M.J. and Datskos P.G. (2004), Cantilever transducers as a platform for chemical and biological sensors, *Rev. Sci. Instruments* 75:2229–2253.
- [15] Strick T.R., Dessinges M.-N., Charvin G., Dekker N.H., Allemand J.-F., Bensimon D. and Croquette V. (2003), Stretching of macromolecules and proteins, *Rep. Prog. Phys.* 66:1–45.
- [16] Kittel C. (1986), *Introduction to solid state physics*, 6th Ed., Wiley, New York, USA, Ch. 3.
- [17] Florin E., Moy V. and Gaub H. (1994), Adhesion force between individual ligand-receptor pairs, *Science* 264:415–417.
- [18] Hinterdorfer P., Baumgartner W., Gruber H.J., Schilcher K. and Schindler H. (1996), Detection and localization of individual antibody-antigen recognition events by atomic force microscopy, *Proc. Natl. Acad. Sci. USA* 93:3477–3481.
- [19] Oesterhelt F., Oesterhelt D., Pfeiffer M., Engel A., Gaub H.E. and Muller D.J. (2000), Unfolding pathways of individual bacteriorhodopsins, *Science* 288:143–146.
- [20] Rief M., Gautel M., Oesterhelt F., Fernandez J.M. and Gaub H.E. (1997), Reversible unfolding of individual titin immunoglobulin domains by AFM, *Science* 276: 1109–1112.
- [21] Lee G.U., Chrisey L.A. and Colton R.J. (1994), Direct measurement of the forces between complementary strands of DNA, *Science* 266:771–773.
- [22] Matsui S. (1997), Nanostructure fabrication using electron beam and its application to nanometer devices, *Proc. IEEE* 85:629–643.
- [23] Snow E.S., Campbell P.M. and Perkins F.K. (1997), Nanofabrication with proximal probes, *Proc. IEEE* 85:601–611.
- [24] Chou S.Y., Krauss, P.R. and Renstrom P.J. (1996), Nanoimprint lithography, *J. Vac. Sci. Technol. B* 14:4129–4133.
- [25] Ishitani, T., Ohnishi T., Madokoro Y. and Kawanami Y. (1991), Focused-ion-beam "cutter" and "attacher" for mi-

- cromachining and device transportation, *J. Vac. Sci. Technol. B* 9:2633–2637.
- [26] Cleland A.N. and Roukes M.L. (1996), Fabrication of high-frequency nanometer scale mechanical resonators from bulk Si crystals, *Appl. Phys. Lett.* 69:2653–2655.
- [27] Cleland A.N. and Roukes M.L. (1998), Nanostructure-based mechanical electrometry, *Nature* 392:160–161.
- [28] Carr D.W., Evoy S., Sekaric L., Craighead H.G. and Parpia J.M. (1999), Measurement of mechanical resonance and losses in nanometer scale silicon wires, *Appl. Phys. Lett.* 75:920–922.
- [29] Berger R., Delamarche E., Lang H.P., Gerber C., Gimzewski J.K., Meyer E. and Güntherodt H.-J. (1997), Surface stress in the self-assembly of alkanethiols on gold, *Science* 276:2021–2024.
- [30] Rief M., Oesterhelt F., Heymann B. and Gaub H.E. (1997), Single molecule force spectroscopy on polysaccharides by atomic force microscopy, *Science* 275:1295–1297.
- [31] Göpel W., Hesse J. and Zemel J.N., Eds. (1994), *Sensors*, vol. 7, Mechanical Sensors, VCH, Weinheim, Germany.
- [32] Meyer G. and Amer N.M. (1988), Novel optical approach to atomic force microscopy, *Appl. Phys. Lett.* 53:1045–1047.
- [33] iMEMS® accelerometer family, Analog Devices Inc., [www.analog.com](http://www.analog.com).
- [34] Klok, B. (1994), Piezoresistive sensors, in Göpel W., Hesse J. and Zemel J.N., Eds., *Sensors*, vol. 7, Mechanical Sensors, VCH, Weinheim, Germany, p. 145–172.
- [35] Datskos P.G. and Thundat, T.G. (2002), Nanocantilever signal transduction using electron transfer, *J. Nanosci. Nanotech.* 2:369–373.
- [36] Yasumura K.Y., Stowe T.D., Chow E.M., Pfafman T., Kenny T.W., Stipe B.C. and Rugar D. (2000), Quality factors in micron- and submicron- thick cantilevers, *J. Microelectromechanical Syst.* 9:117–125.
- [37] Cleland A.N. and Roukes M.L. (2002), Noise processes in nanomechanical resonators, *J. Appl. Phys.* 92:2758–2769.
- [38] Hansen O. and Boisen A. (1999), Noise in piezoresistive atomic force microscopy, *Nanotechnology* 10:51–60.
- [39] Harley J.A. and Kenny T.W. (2000) 1/F noise considerations for the design and process optimization of piezoresistive cantilevers, *J. Microelectromechanical Syst.* 9:226–235.
- [40] Raiteri R., Grattarola M., Butt H.-J. and Skládal P. (2001), Micromechanical cantilever-based sensors, *Sens. Actuators B* 79:115–126.
- [41] Zinoviev K., Plaza J.A., Domínguez C. and Lechuga L. (2004), Multi-cantilever array fabrication technology, in Digest of technical papers, 18th European Conference on Solid-State Sensors (Euroensors 2004), September 12–15, 2004, Rome, Italy, p. 536–537.
- [42] Ji H.-F., Finot E., Dabestani R., Thundat T., Brown G.M. and Britt P.F. (2000), A novel self-assembled monolayer (SAM) coated microcantilever for low level caesium detection, *Chem. Commun.* 2000:457–458.
- [43] Hagleitner C., Hierlemann A., Lange D., Kummer A., Kerness N., Brand O. and Baltes H. (2001), Smart single-chip gas sensor microsystem, *Nature* 414:293–296.
- [44] Li Y., Vancura C., Hagleitner C., Lichtenberg J., Brand O. and Baltes H. (2003), Very high Q-factor in water achieved by monolithic, resonant cantilever sensor with fully integrated feedback, *Proceedings 2nd IEEE International Conference on Sensors, IEEE Sensors 2003*, October 22–24, 2003, Toronto, Canada, p. 809–813.
- [45] Ghatnekar-Nilsson S., Forsén E., Abadal G., Verd J., Campabadal F., Pérez-Murano F., Esteve J., Barniol N., Boisen A. and Montelius L. (2005), Resonators with integrated CMOS circuitry for mass sensing applications, fabricated by electron beam lithography, *Nanotechnology* 16:98–102.
- [46] Abadal, G., Teva J., Esteve J., Pérez-Murano F. and Barniol N. (2004), A method for mass detection testing in the femto-gram range of micro/nano-cantilever based mass sensors, *Abstracts book, Micro and Nano Engineering 2004*, 19–22 September 2004, Rotterdam, The Netherlands, p. 240–241.
- [47] Gupta A., Akin D. and Bashir R. (2004), Single virus particle mass detection using microresonators with nanoscale thickness, *Appl. Phys. Lett.* 84:1976–1978.
- [48] Villanueva G., Montserrat J., Pérez-Murano F., Rius G. and Bausells J. (2004), Submicron piezoresistive cantilevers in a CMOS-compatible technology for intermolecular force detection, *Microelectron. Eng.* 73–74:480–486.

## About the author

Joan Bausells is Research Professor at the National Microelectronics Center (CNM) of the Spanish Research Council (CSIC). His early research work was in the field of solid state physics, and he received a Ph.D. in Physics from the University of Barcelona in 1986. In the same year he joined CNM, after having worked for five years in the semicon-

ductor industry. His initial activities at CNM were related to microelectronic fabrication processes. Since 1990 his research activity has been oriented to electronic and micromechanical devices for sensors and integrated microsystems, mainly for mechanical and chemical measurements. He is currently interested in the evolution from micromechanical to nanomechanical systems and is heading the Nanotech-

nology Group of IMB-CNM. In this context he has been involved in the development of micro- and nano-electromechanical systems for applications in biochemical analysis. Since 1992 he is also a part time professor at the Electronics Engineering Department of the Autonomous University of Barcelona (UAB). He is a member of the Catalan Physical Society of the Institut d'Estudis Catalans.